

SYSTÈMES DE CONDUITES

EN ACIER INOXYDABLE

POUR LUBRIFICATION ET

REFROIDISSEMENT HAUTE PRESSION



Typ0

Système 1/8"
Intérieur Ø 3,2 mm

Typ1

Système 1/4"
Intérieur Ø 5,8 mm

Typ2

Système 1/2"
Intérieur Ø 11 mm

Typ 3

Système 3/4"
Intérieur Ø 19 mm

INDIVIDUELS & FLEXIBLES

Hirt[®]
LINE



Le système original de conduites flexibles | Hirt-Line®

Nos conduites flexibles sont extensibles à volonté, inoxydables et ont une longue durée de vie. Toutes les pièces sont usinées avec précision, résistent à la chaleur et aux substances chimiques. Nos conduites flexibles se laissent facilement assembler, adapter, rallonger ou raccourcir manuellement. Ni la pression du liquide de refroidissement ni les vibrations des machines ne peuvent changer leur position. Elles résistent à une pres-

sion supérieure à 100 bars. Elles peuvent être utilisées sur des machines-outils et des installations de production, essentiellement sur des tours, des fraiseuses, des rectifieuses, des machines à scier, des machines de remplissage. Elles sont appropriées pour des émulsions, des huiles de coupe et de refroidissement, des substances chimiques et pour le refroidissement par air.

Propriétés:

- Grande précision de fixation (par vissage) et de réglage du jet
- Résistance aux hautes températures, aux substances chimiques, aux copeaux, à la pression et aux vibrations
- Matériau résistant à la corrosion 1.4305 V2A (sur demande en V4A)
- Résistance à l'usure
- Résistance à une pression >100 bars
- Champ d'utilisation - 30° C jusqu'à +60° C
- En option: système ES extra robuste jusqu'à 300 ° C (disponible sur demande)
- Systèmes disponibles en 4 tailles, tous compatibles entre eux
- Longue durée de vie
- Utilisable directement sur l'outil (raccordement AGW/outil motorisé)
- Possibilité de combinaisons multiples
- Gamme de produits bien conçue et efficace
- Utilisable dans l'industrie alimentaire
- Éléments de connexion pour chaque machine
- Kits de base disponibles dans chaque système



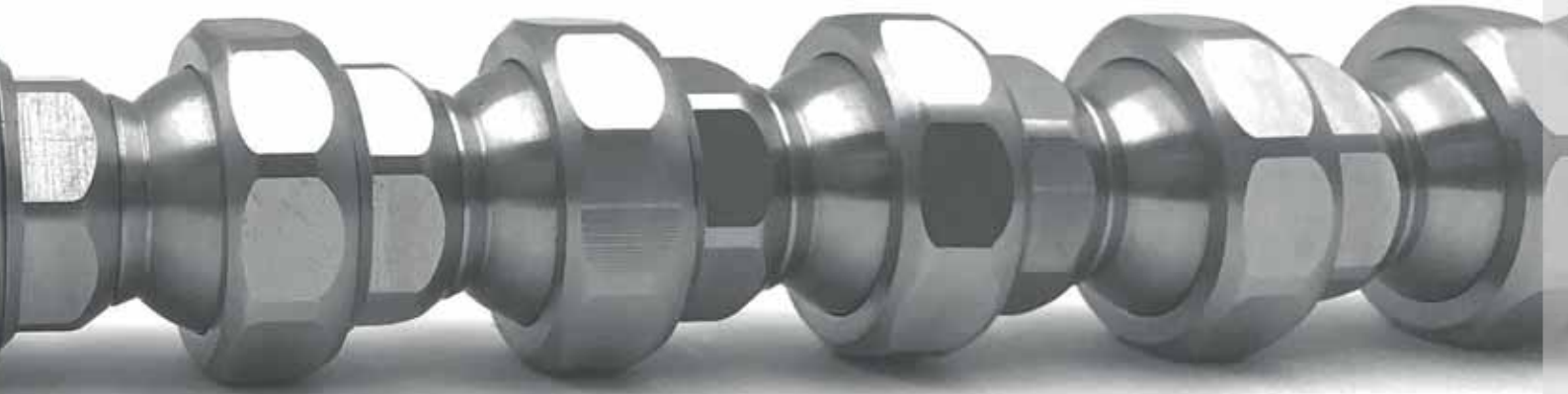

Prolongation de la durée de vie des outils et réduction des temps d'arrêt des machines-outils

Des tuyaux flexibles en matière plastique sont certes des tuyaux de refroidissement très flexibles, mais avec eux, la sécurité d'exploitation exigée n'est assurée que de façon limitée. Des tuyaux flexibles standards sont souvent déréglés par des vibrations ou des copeaux et le liquide de refroidissement n'arrive plus là où il est

utile. Arrêts-machine et détériorations d'outils peuvent être évités. En utilisant nos flexibles de lubrification et de refroidissement pour vos tours, fraiseuses, rectifieuses, vous augmenterez votre productivité, quelque soit le fabricant des machines.

MADE IN SWITZERLAND –

C'est la promesse de qualité faite par Hirt-Line®

Une promesse que nous tenons en fabriquant nous-mêmes nos produits, en ayant une production flexible et en répondant à des exigences élevées en matière de qua-

lité. Qu'il s'agisse de produire en série des produits standards ou de fabriquer des modèles spéciaux sur mesure, nous sommes volontiers à votre disposition!

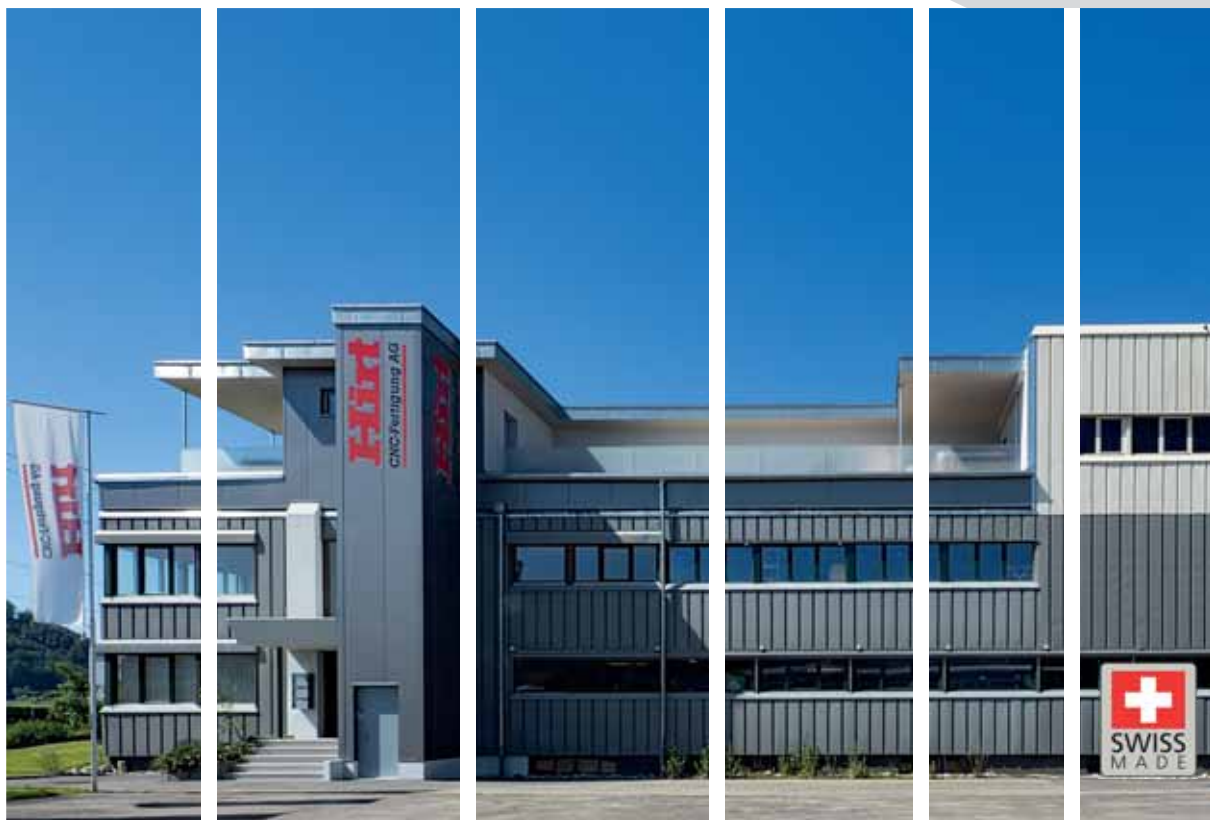



4 tailles de systèmes

Typ0 | 1/8" | Section de passage Ø 3,2 mm | Filetage M8 x 0,75

Typ1 | 1/4" | Section de passage Ø 5,8 mm | Filetage M14 x 1,0

Typ2 | 1/2" | Section de passage Ø 11,0 mm | Filetage M24 x 1,25

Typ3 | 3/4" | Section de passage Ø 19,0 mm | Filetage M34 x 1,25

Tous compatibles entre eux



Adaptateurs machine

À côté des filetages tubulaires G1/8", G1/4", G3/8", G1/2", G3/4", G1" et des filetages métriques M5 x 0,8, ainsi que M14 x 1,0 jusqu'à M20 x 1,5, nous fournissons aussi des filetages coniques et des adaptateurs de tête sphérique, aux dimensions de Ø10 mm, Ø12 mm, Ø14 mm, Ø15 mm, ainsi que divers adaptateurs spéciaux correspondants.

Sur demande, vous pouvez obtenir votre adaptateur de raccordement spécial!



Éléments de base

Les éléments de base du système Hirt-Line ont un diamètre intérieur de 3,2 mm, 5,8 mm, 11,0 mm et 19,0 mm. La multitude de longueurs standards différentes, qui va de 9,3 mm et 100 mm, jusqu'à 1000 mm, permet d'installer et de fixer le jet de refroidissement, exactement à l'endroit voulu.



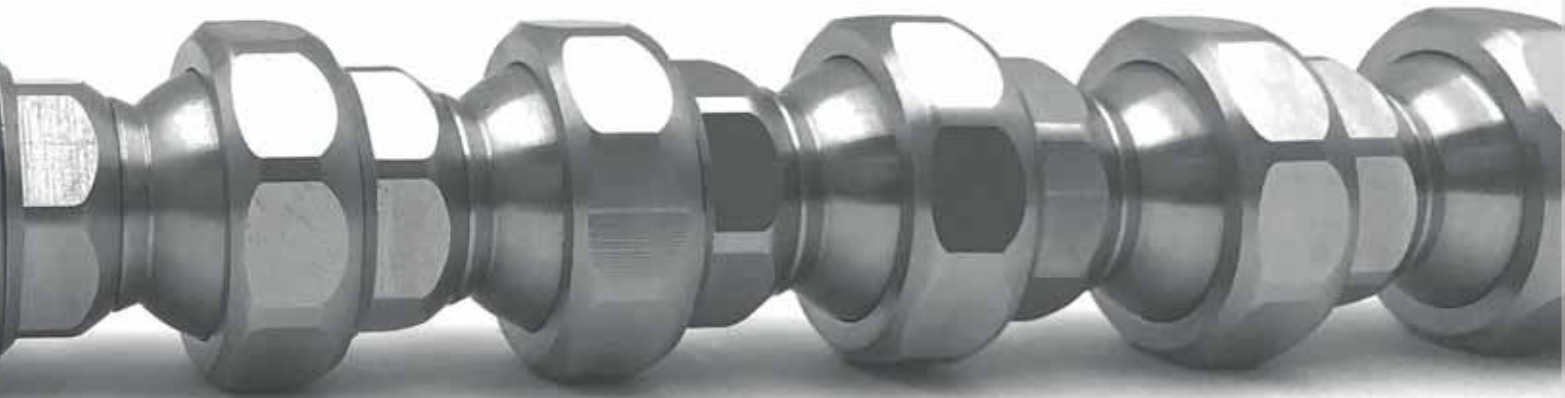

Éléments coudés

Le système Hirt-Line® offre un grand nombre d'éléments coudés pour chaque taille de système. Qu'il s'agisse du Typ0, Typ1, Typ2 ou Typ3, nous avons l'élément correspondant. Comme, par exemple, des raccords coudés à 90°, des raccords multiples, des raccords en T ou en Y. Nous garantissons un maximum de flexibilité du système grâce au vaste choix. Raccords à visser spéciaux sur demande!



Buses

Les buses sont en matériau 1.4305 (V2A). Elles résistent à la chaleur et sont disponibles dans une section de passage allant de Ø 0,5 mm, Ø 10,0 mm, jusqu'à Ø 19,0 mm. Nos nombreuses buses plates, avec différentes largeurs de fente, répondent à tous les souhaits. Elles sont idéales pour la dispersion et le refroidissement ainsi que pour le meulage plat et cylindrique. En outre, quelques buses spéciales sont disponibles, soit avec plusieurs perçages, soit avec des mini-fentes. Toutes les buses ont été optimisées pour un refroidissement parfait!



Accessoires

Les accessoires Hirt-Line® se composent de produits fabriqués par nous-mêmes tels que raccords rapides, écrous moletés ou capuchons de fermeture ainsi que pièces de réduction, pour combiner les systèmes entre eux. En parallèle, nous fournissons également des articles de fabrication extérieure, adaptés aux besoins, tels que robinets à rotule (boisseau sphérique) et clés plates. Au travers de cet assortiment, vous êtes assurés de disposer à l'avenir d'une arrivée stable et optimale de réfrigérant, en particulier dans le cas d'applications individuelles.



Tous les articles sont disponibles dans chaque système et en différentes tailles. (à titre d'exemple: illustration système Typ2)

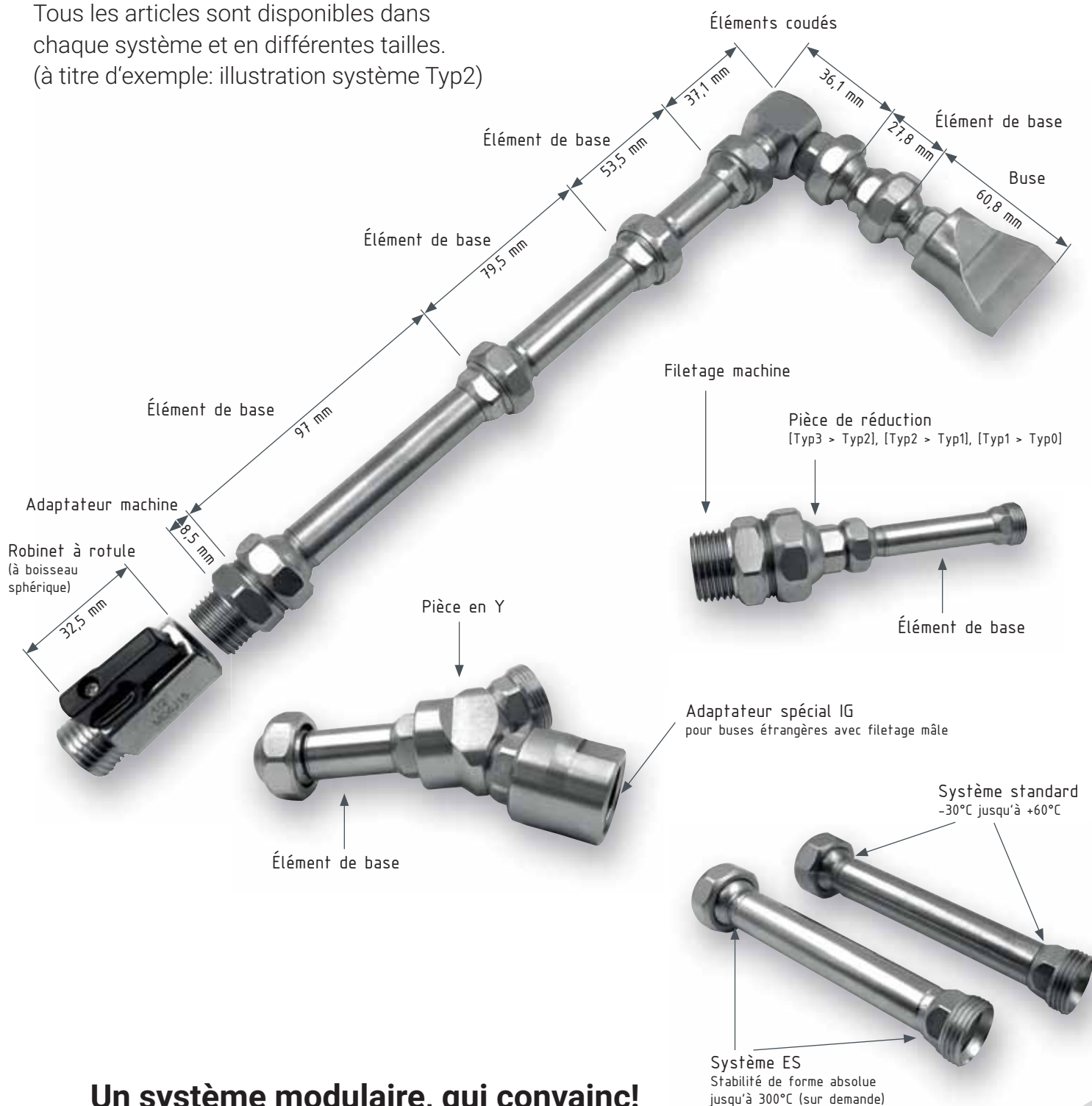

Un système modulaire, qui convainc!

Une production réussie peut être basée sur le système Hirt-Line®. Par contre, le système est basé sur des composants individuels. Pour permettre aux clients de suivre leur propre voie en matière de conception et de mise en œuvre de leurs installations, Hirt-Line® fait en sorte que tous les composants et leurs données soient disponibles individuellement. Hirt-Line® a rassemblé tous les éléments dans un catalogue, afin de faciliter et d'accélérer le processus de commande.

VUE D'ENSEMBLE DES PRODUITS

Typ0 [1/8"]



Le montage du tout nouveau système Typ0 est rapide. Typ0 se laisse facilement installer sur l'outil. Le système comprend une multitude de buses de \varnothing 0,5 mm à \varnothing 3,0 mm, jusqu'à des buses avec plusieurs orifices de sortie. Pour l'utilisateur, un large choix d'adaptateurs machine, allant de M5 x 0,8 à M10 x 1,5, jusqu'à des adaptateurs à rotule de \varnothing 10,0 mm et aussi différents éléments de base et éléments coudés sont disponibles, qui lui offrent la flexibilité et la variabilité nécessaires lors de l'usinage de ses produits.

Données techniques:

- Taille Typ0 (1/8")
- Section de passage Ø 3,2 mm
- Résistance à la pression jusqu'à 80 bars
- Champ d'utilisation -30° C jusqu'à +60° C
- En option, système ES extra robuste jusqu'à + 300° C (disponible sur demande)
- Filetage (éléments) M8 x 0,75
- Matériau 1.4305 (V2A)

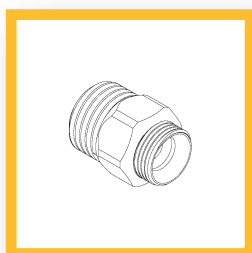
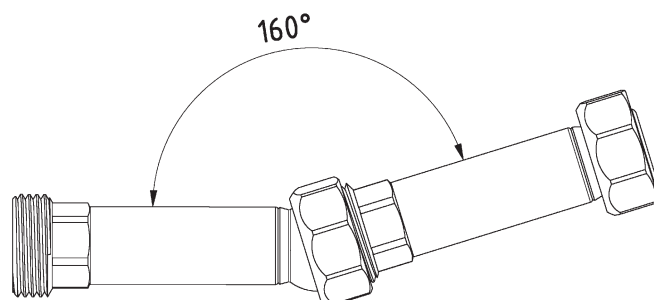
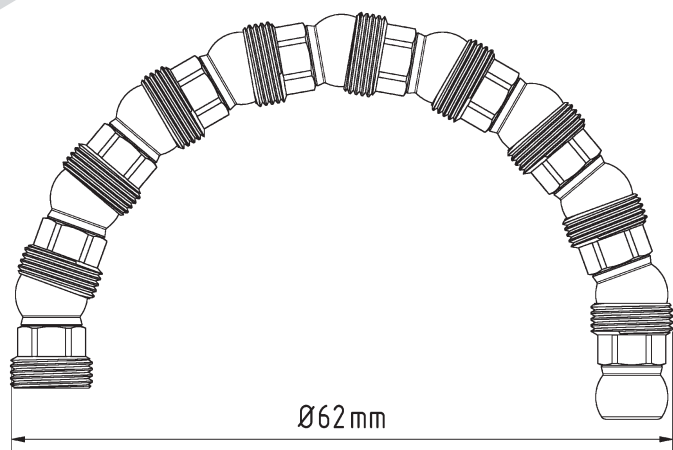

ADAPTATEURS MACHINE

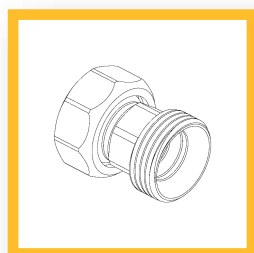

ÉLÉMENTS DE BASE

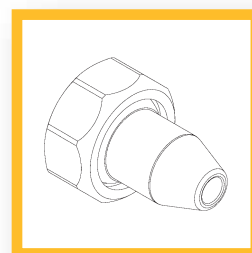

BUSES

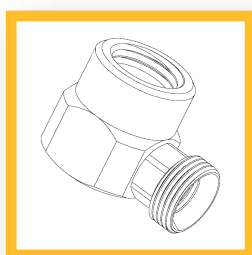

ÉLÉMENTS COUDÉS

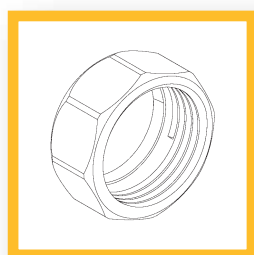

ACCESSOIRES

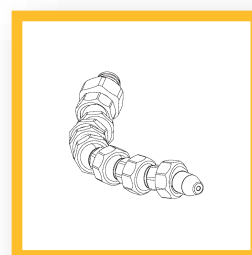

ACCESSOIRES Typ0

Typ0 [Système 1/8"]

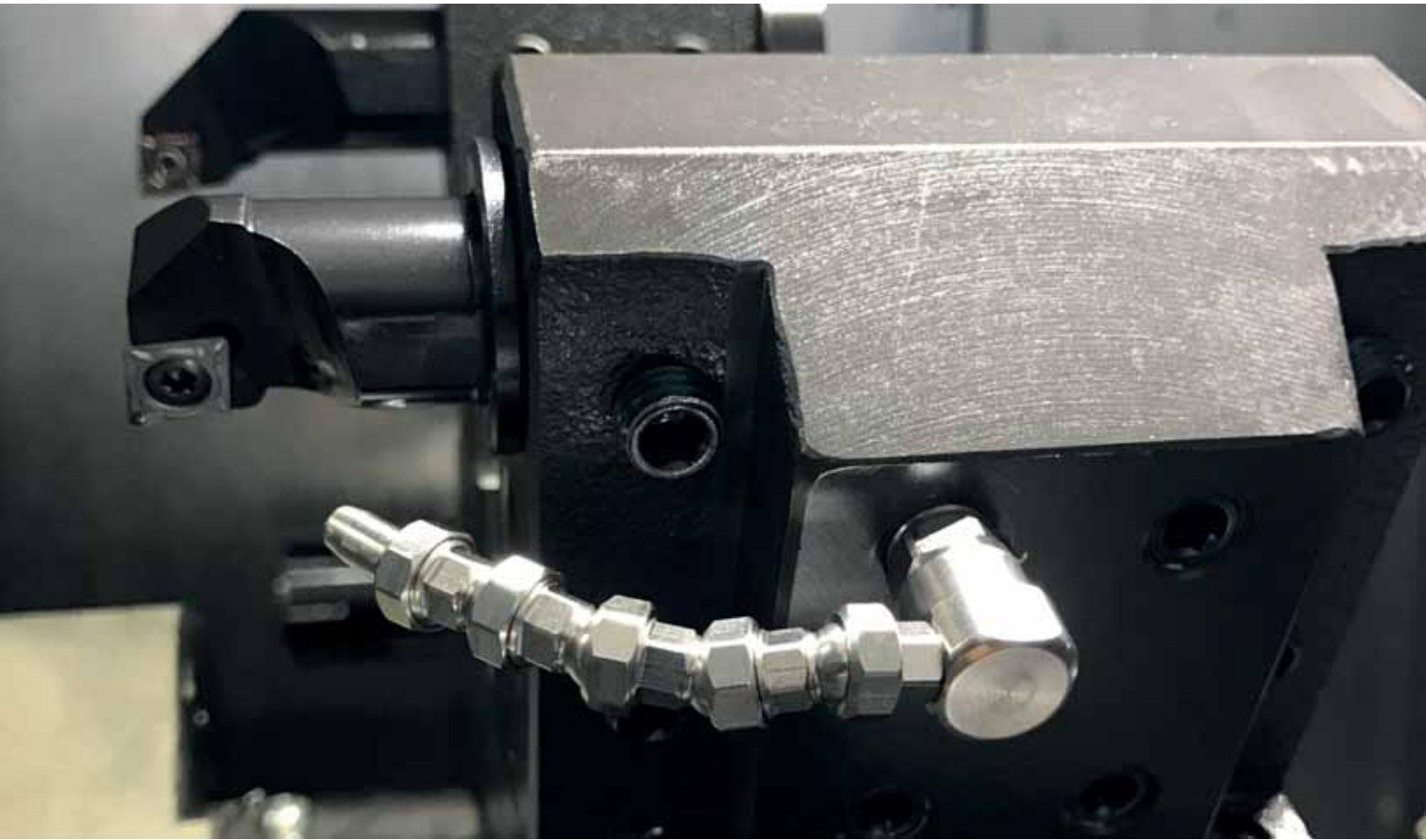

Éléments de base | Basic Elements

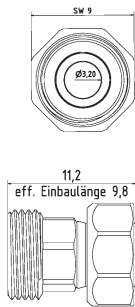

0-GE

L. = 11,2 mm | L. effective = 9,8 mm
l = 11,2 mm effective l = 9,8 mm

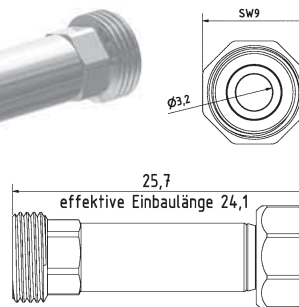

0-GE-25

L. = 25,7 mm | L. effective = 24,1 mm
l = 25,7 mm effective l = 24,1 mm

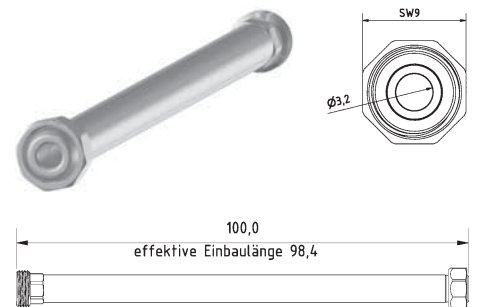

0-GE-100

L. = 100 mm | L. effective = 98,4 mm
l = 100 mm effective l = 98,4 mm

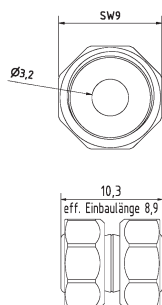

0-GE-DK Élément spécial

L. = 10,3 mm | L. effective = 8,9 mm double rotule
l = 10,3 mm effective l = 8,9 mm double ball

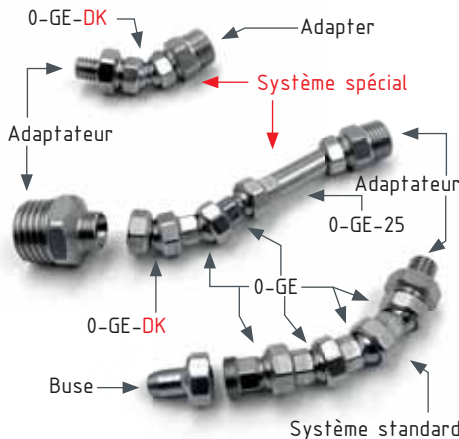

Adaptateurs machine/buse | Machine-/Nozzle Adapter

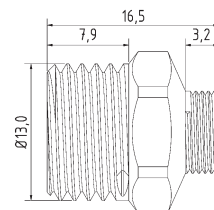
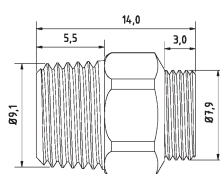
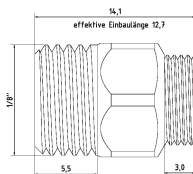
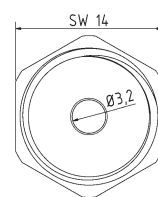
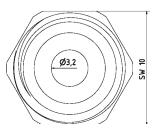

0-AD-18

Raccord adaptateur filetage 1/8"
adaptor piece thread 1/8"

0-AD-18-PT

Raccord adaptateur filetage 1/8" PT (filetage NPT)
adaptor piece thread 1/8" PT (NPT thread)

0-AD-14

Raccord adaptateur filetage G 1/4"
adaptor piece thread 1/4"

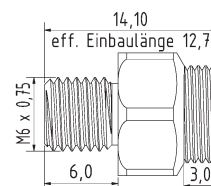
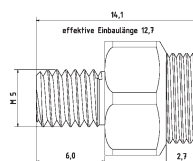
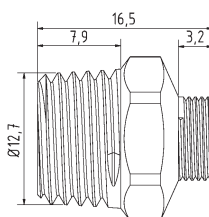
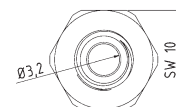
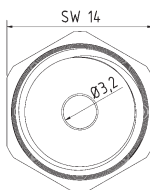

0-AD-14-PT

Raccord adaptateur filetage G 1/4" PT (filetage NPT)
adaptor piece thread 1/4" PT (NPT thread)

0-AD-M5

Raccord adaptateur M 5 x 0,8 filetage métrique
adaptor piece M 5 x 0,8 metric thread

0-AD-6075

Raccord adaptateur filetage M6 x 0,75
adaptor piece M6 x 0,75 metric thread

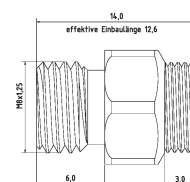
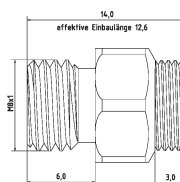
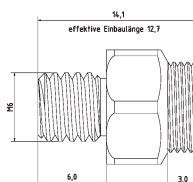
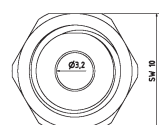
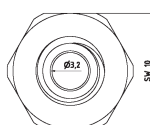

0-AD-M6

Raccord adaptateur M 6 x 1 filetage métrique
adaptor piece M 6 x 1 metric thread

0-AD-81

Raccord adaptateur M 8 x 1 filetage métrique
adaptor piece M 8 x 1 metric thread

0-AD-M8

Raccord adaptateur M 8 x 1,25 filetage métrique
adaptor piece M 8 x 1,25 metric thread

Typ0 [Système 1/8"]

Adaptateurs machine/buse | Machine-/Nozzle Adapter

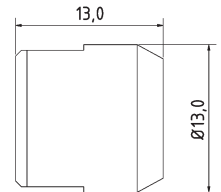
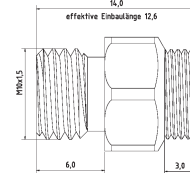
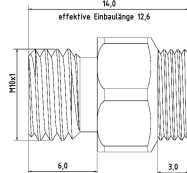
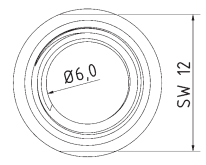
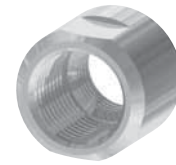
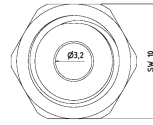
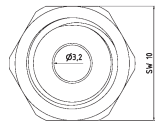

0-AD-M101

Raccord adaptateur M 10 x 1 filetage métrique
adaptor piece M 10 x 1 metric thread

0-AD-M10

Raccord adaptateur M 10 x 1,5 filetage métrique
adaptor piece M 10 x 1,5 metric thread

0-AD-0GE-18

Raccord adaptateur pour buses étrangères avec filetage mâle, filetage femelle 0-GE sur femelle 1/8"
adapter piece for external nozzles with male thread, female 0-GE to female 1/8"

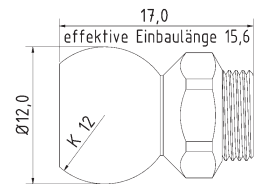
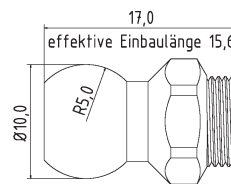
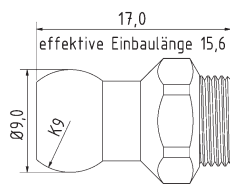
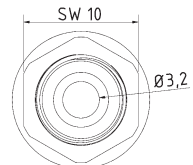
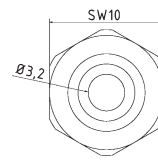
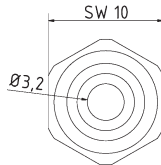

0-AD-K9

Raccord avec rotule Ø 9
adaptor piece ball Ø 9 mm

0-AD-K10

Raccord adaptateur rotule Ø10
adaptor piece ball Ø10

0-AD-K12

Raccord avec rotule Ø 12 (par ex. MORI SEIKI)
adaptor piece ball Ø 12 mm (e.g. MORI SEIKI)

Éléments coudés | Elbows

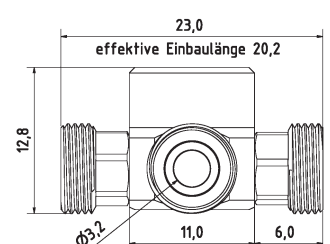
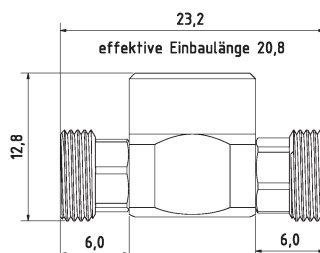
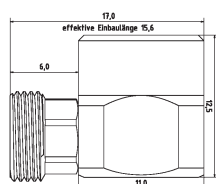
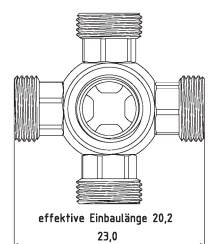
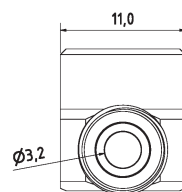
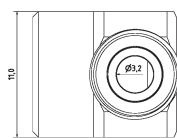

0-WV-1

Raccord coudé à visser
elbow piece fixed

0-WV-2

Raccord en T à visser
T-piece fixed

0-WV-4

Collecteur
Manifold

Éléments coudés | Elbows

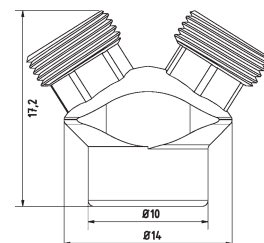
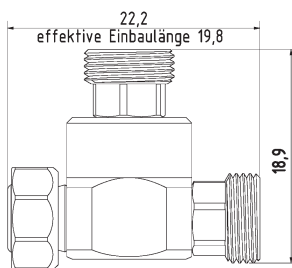
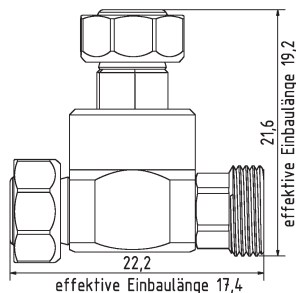
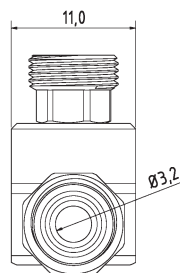
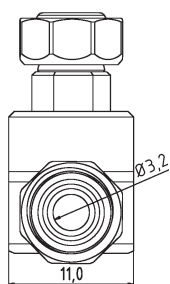
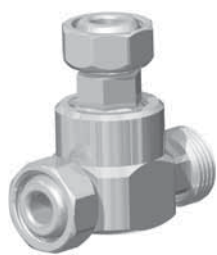

0-WV-R

Raccord obturateur pour buse annulaire
locking tappet to ring nozzle

0-WV-R-2K

Raccord en T pour bague et buse
T-piece for ring and nozzle

0-YV

Raccord en Y, à visser
Y-piece fixed

Buses | Nozzles

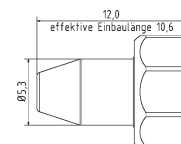
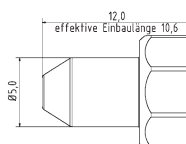
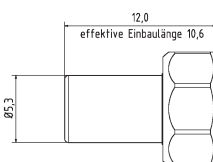
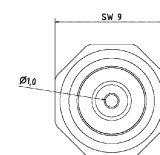
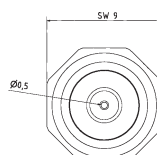
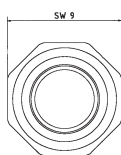

0-DU-0

Buse sans perçage
nozzle straight without drilling

0-DU-05

Buse à jet rectiligne perçage Ø 0,5 mm
nozzle straight Ø 0,5 mm

0-DU-10

Buse à jet rectiligne perçage Ø 1,0 mm
nozzle straight Ø 1,0 mm

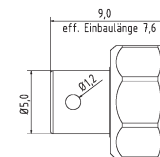
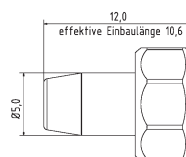
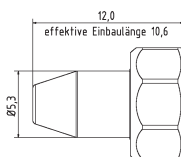
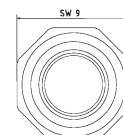
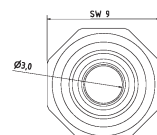
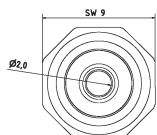

0-DU-20

Buse à jet rectiligne perçage Ø 2,0 mm
nozzle straight Ø 2,0 mm

0-DU-30

Buse à jet rectiligne perçage Ø 3,0 mm
nozzle straight Ø 3,0 mm

0-DU-90-1

Buse à jet 90° perçage 1 x Ø 1,2 mm
nozzle 90° drill hole 1 x Ø 1,2 mm

Typ0 [Système 1/8"]

Buses | Nozzles

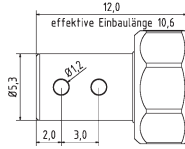
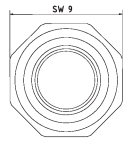

0-DU-90-2

Buse à jet 90° perçage 2 x Ø 1,2 mm
nozzle 90° drill hole 2 x Ø 1,2 mm

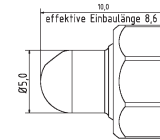
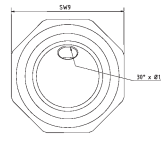

0-DU-30-1.5

Buse à jet 30° perçage Ø 1,5 mm
nozzle 30° drill hole Ø 1,5 mm

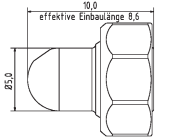
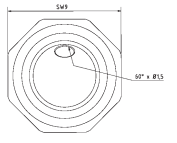

0-DU-60-1.5

Buse à jet 60° perçage Ø 1,5 mm
nozzle 60° drill hole Ø 1,5 mm

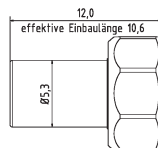
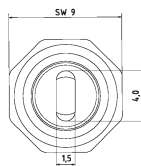

0-DU-415

Buse à jet rectiligne, avec fente 4 x 1,5 mm
nozzle straight with slit 4 x 1,5 mm

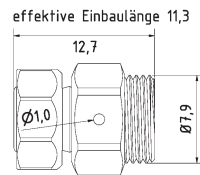
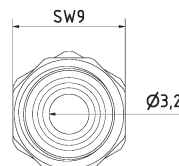

0-DU-R

Élément buse annulaire perçage Ø 1,0 mm
ring nozzle element drill hole Ø 1,0 mm

Accessoires | Accessories

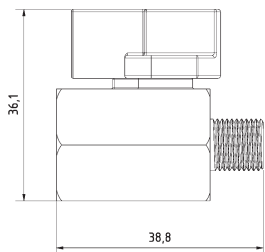
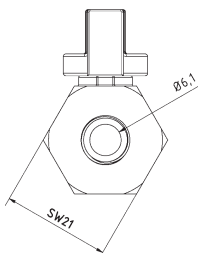
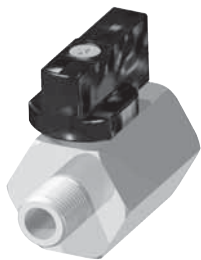

KH-18

Mini-robinet à rotule filetage 1/8",
acier inoxydable

mini ball valve thread 1/8" brass chrome-plated

KH-18-SS

Mini-robinet à rotule filetage 1/8",
acier inoxydable

mini ball valve thread 1/8" stainless steel

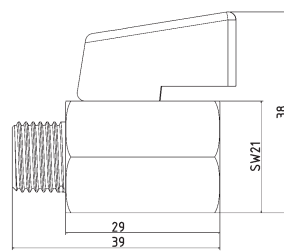
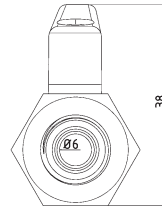

KH-14

Mini-robinet à rotule filetage 1/4",
laiton chromé

mini ball valve thread 1/4" brass chrome-plated

KH-14-SS

Mini-robinet à rotule filetage 1/4",
acier inoxydable

mini ball valve thread 1/4" stainless steel

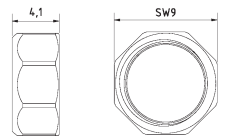

0-MU

Écrou standard
screw nut (default)

Accessoires | Accessories

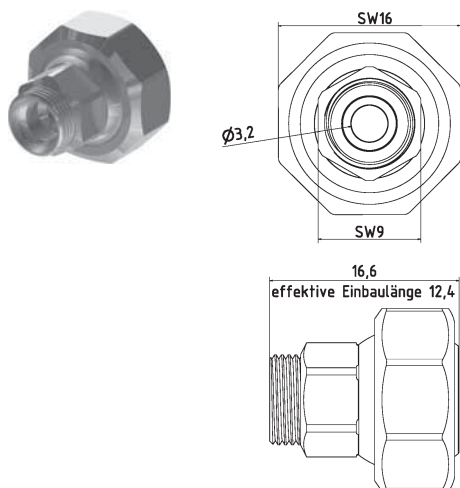

RE-1-0

Pièce de réduction Typ1 sur Typ0
reduction Type 1 to Type 0



SW-6

Clé plate en acier SW 6
open end wrench SW 6



SW-9

Clé plate en acier SW 9
open end wrench SW 9

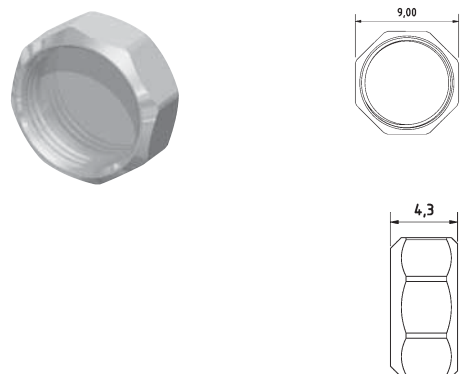

0-VK

Capuchon de fermeture Typ0
cap type 0

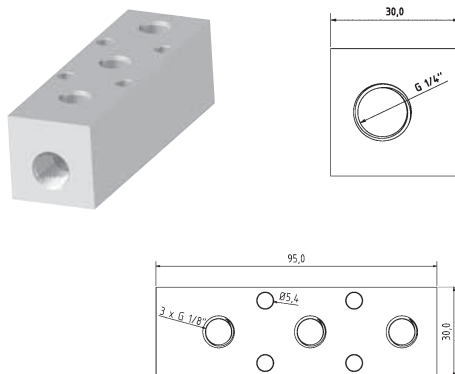

VB-3-18

Bloc distributeur entrée frontale filetage 1/4"
manifold block entrance front end 1/4"

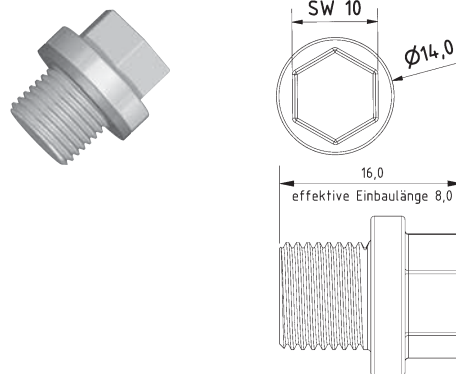

VB-3-18-BS

Bouchon obturateur avec filetage 1/8"
blank plug with thread 1/8"

Kit de base | Basic Set

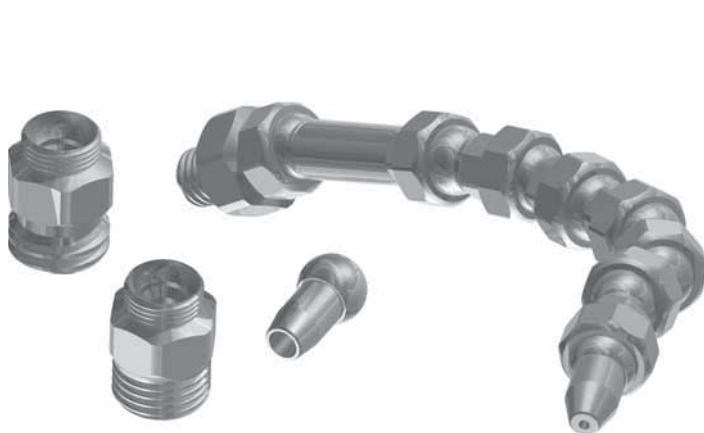

0-GS

Kit de base Typ0 Système 1/8" L. = 110 mm

basic set Type0 1/8" system l = 110 mm

6 x 0-GE, 1 x 0-GE-25, 1 x 0-AD-18, 1 x 0-AD-M6, 1 x 0-AD-101, 1 x 0-DU-10

1 x 0-DU-30, 1 x SW-6, 1 x SW-9



0-GS-R

Kit de buses annulaires Ø = 60mm

(1 x 0-WV-R, 20 x 0-DU-R)

ring nozzle set Ø = 60mm

(1 x 0-WV-R, 20 x 0-DU-R)

VUE D'ENSEMBLE DES PRODUITS

Typ1 [1/4"]



Le système Typ1 est destiné à toutes les applications sur machines, allant jusqu'à un débit maximal de 170 litres/mn. Ce système, avec des buses annulaires de Ø 1,6 mm jusqu'à Ø 5,0 mm ainsi que des buses plates et des buses avec plusieurs perçages, est un système standard pour toute machine. Il existe un vaste choix d'adaptateurs machine (depuis M8 x 1,0 jusqu'à M14 x 1,5 et G3/8"). Il existe aussi différents adaptateurs à rotule avec un Ø 14,0 mm ainsi que des éléments de base ou des éléments coudés. Tous ces éléments garantissent une installation sans problème.

DONNÉES TECHNIQUES:

- Taille Typ1 (1/4")
- Section de passage \varnothing 5,8 mm
- Résistance à la pression au delà de 100 bars
- Champ d'utilisation -30° C jusqu'à +60° C
- En option, système ES extra robuste jusqu'à + 300° C (disponible sur demande)
- Filetage (éléments) M14 x 1
- Matériau 1.4305 (V2A)

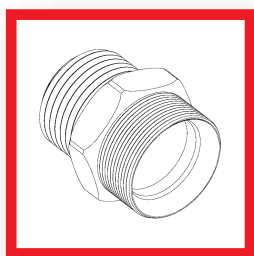
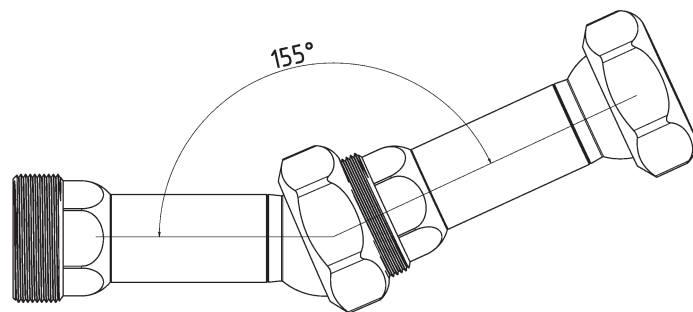
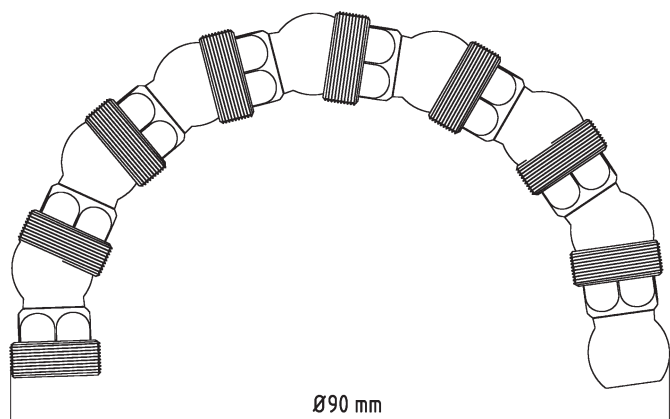

ADAPTATEURS MACHINE

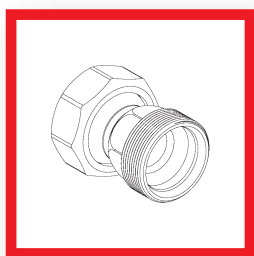

ÉLÉMENTS DE BASE

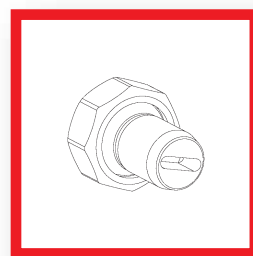

BUSES

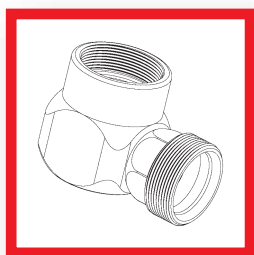

ÉLÉMENTS COUDÉS

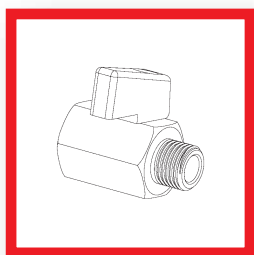

ACCESSOIRES

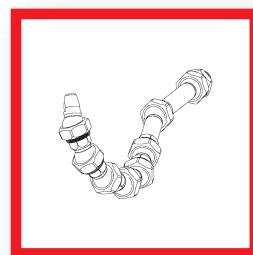

ACCESSOIRES Typ1

Typ1 [Système 1/4"]

Éléments de base | Basic Elements

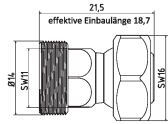
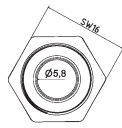

1-GE

L. = 21,5 mm | L. effective = 18,7 mm
l = 21,5 mm effective l = 18,7 mm

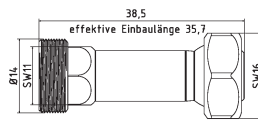
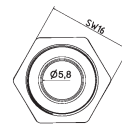

1-GE-2

L. = 38,5 mm | L. effective = 35,7 mm
l = 38,5 mm effective l = 35,7 mm

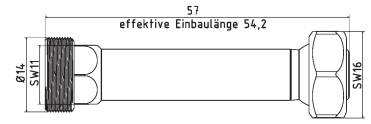
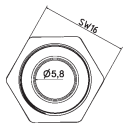

1-GE-3

L. = 57 mm | L. effective = 54,2 mm
l = 57 mm effective l = 54,2 mm

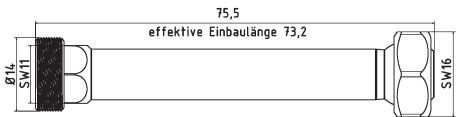
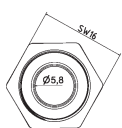

1-GE-4

L. = 75,5 mm | L. effective = 73,2 mm
l = 75,5 mm effective l = 73,2 mm

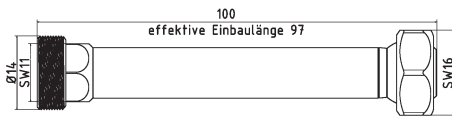
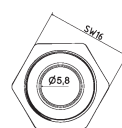

1-GE-100

L. = 100 mm | L. effective = 97 mm
l = 100 mm effective l = 97 mm

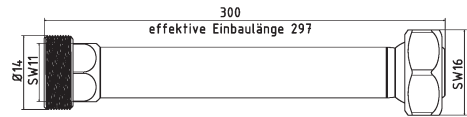
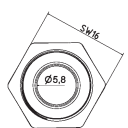

1-GE-300

L. = 300 mm | L. effective = 297 mm
l = 300 mm effective l = 297 mm

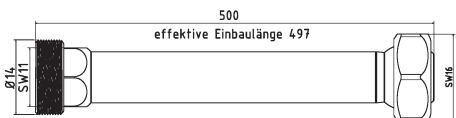
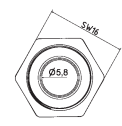

1-GE-500

L. = 500 mm | L. effective = 497 mm
l = 500 mm effective l = 497 mm

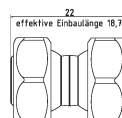
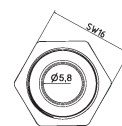

1-GE-DK Élément spécial

L. = 22 mm | L. effective = 18,7 mm double rotule
l = 22 mm effective l = 18,7 mm double ball

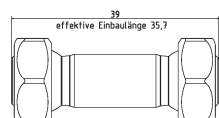
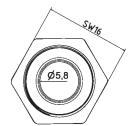

1-GE-2-DK Élément spécial

L. = 39 mm | L. effective = 35,7 mm double rotule
l = 39 mm effective l = 35,7 mm double ball

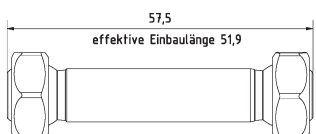
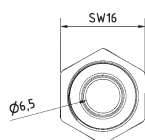

1-GE-3-DK Élément spécial

L. = 57,5 mm | L. effective = 51,9 mm double rotule
l = 57,5 mm effective l = 51,9 mm double ball

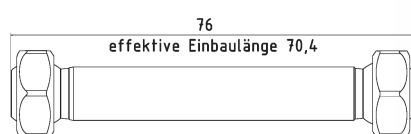
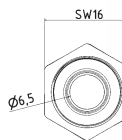

1-GE-4-DK Élément spécial

L. = 76 mm | L. effective = 70,4 mm double rotule
l = 76 mm effective l = 70,4 mm double ball

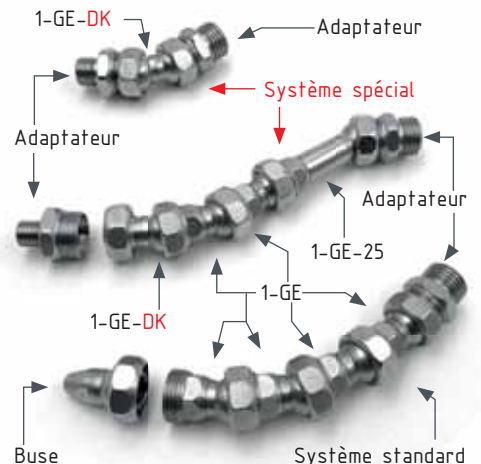

Adaptateurs machine/buse | Machine-/Nozzle Adapter

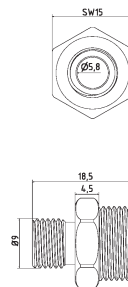
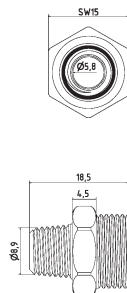
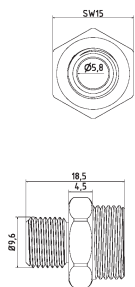

1-AD-18

Raccord adaptateur filetage G 1/8"
adaptor piece thread 1/8"

1-AD-18-PT

Raccord adaptateur filetage G 1/8" PT (filetage NPT)
adaptor piece thread 1/8" PT (NPT thread)

1-AD-18-U

Raccord adaptateur filetage G 1/8" U (filetage avec gorge)
adaptor piece thread 1/8" U (Undercut thread)

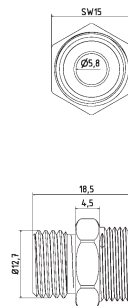
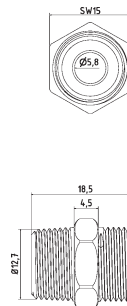
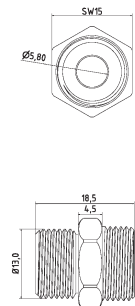

1-AD-14

Raccord adaptateur filetage G 1/4"
adaptor piece thread 1/4"

1-AD-14-PT

Raccord adaptateur filetage G 1/4" PT (filetage NPT)
adaptor piece thread 1/4" PT (NPT thread)

1-AD-14-U

Raccord adaptateur filetage G 1/4" U (filetage avec gorge)
adaptor piece thread 1/4" U (Undercut thread)

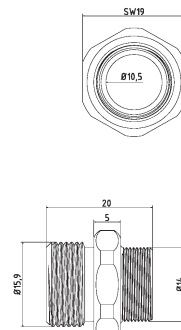
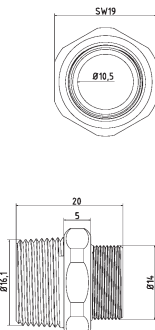
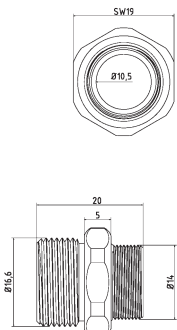

1-AD-38

Raccord adaptateur filetage G 3/8"
adaptor piece thread 3/8"

1-AD-38-PT

Raccord adaptateur filetage G 3/8" PT (filetage NPT)
adaptor piece thread 3/8" PT (NPT thread)

1-AD-38-U

Raccord adaptateur filetage G 3/8" U (filetage avec gorge)
adaptor piece thread 3/8" U (Undercut thread)

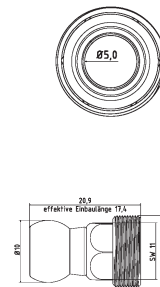
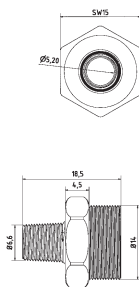
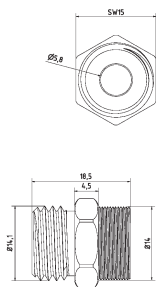

1-AD-9-16-18UNF

Raccord adaptateur filetage G 9/16"
adaptor piece thread 9/16"

1-AD-1-16PT

Raccord adaptateur filetage G 1/16" PT (filetage NPT)
adaptor piece thread 1/16" PT (NPT thread)

1-AD-K10

Raccord avec rotule Ø 10 (par ex. Traub)
adaptor piece ball Ø 10 mm (e.g. Traub)

Typ1 [Système 1/4"]

Adaptateurs machine/buse | Machine-/Nozzle Adapter

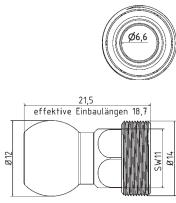

1-AD-K12

Raccord avec rotule Ø 12 (par ex. MORI SEIKI)
adaptor piece ball Ø 12 mm (e.g. MORI SEIKI)

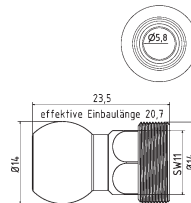

1-AD-K14

Raccord avec rotule Ø 14 (par ex. Wenk)
adaptor piece ball Ø 14 mm (e.g. Wenk)

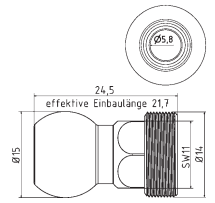

1-AD-K15

Raccord avec rotule Ø 15 (par ex. Okuma)
adaptor piece ball Ø 15 mm (e.g. Okuma)

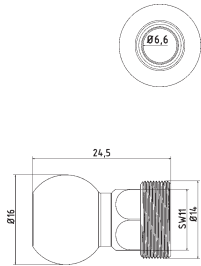

1-AD-K16

Raccord avec rotule Ø 16 (par ex. Okuma)
adaptor piece ball Ø 16 mm (e.g. Okuma)

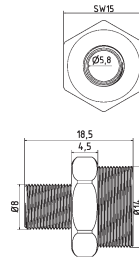

1-AD-81

Raccord adaptateur filetage M8 x 1
adaptor piece M8 x 1 metric thread

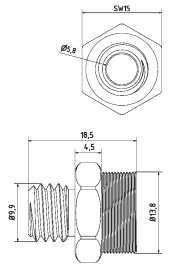

1-AD-101

Raccord adaptateur filetage M10 x 1
adaptor piece M10 x 1 metric thread

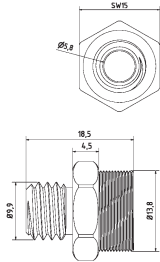

1-AD-101.5

Raccord adaptateur filetage M10 x 1.5
adaptor piece M10 x 1.5 metric thread

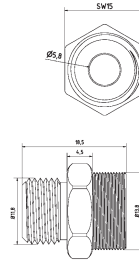

1-AD-121

Raccord adaptateur filetage M 12 x 1
adaptor piece M 12 x 1 metric thread

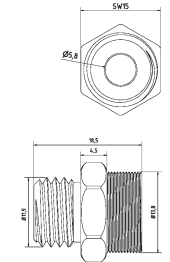

1-AD-121.5

Raccord adaptateur filetage M 12 x 1,5
adaptor piece M 12 x 1,5 metric thread

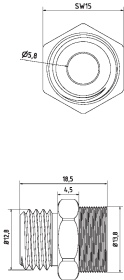

1-AD-131.5

Raccord adaptateur filetage M 13 x 1,5
adaptor piece M 13 x 1,5 metric thread

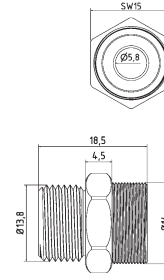

1-AD-141

Raccord adaptateur filetage M 14 x 1
adaptor piece M 14 x 1 metric thread

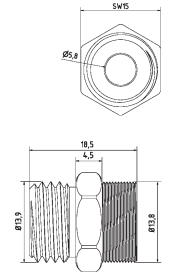

1-AD-141.5

Raccord adaptateur filetage M 14 x 1,5
adaptor piece M 14 x 1,5 metric thread

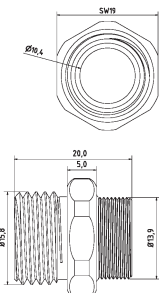

1-AD-161.5

Raccord adaptateur filetage M 16 x 1,5
adaptor piece M 16 x 1,5 metric thread

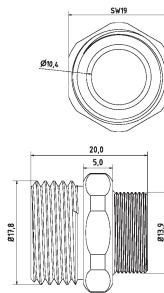

1-AD-181.5

Raccord adaptateur filetage M 18 x 1,5
adaptor piece M 18 x 1,5 metric thread

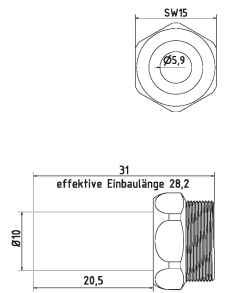

1-AD-10L

Raccord adaptateur pour raccord hydraulique 10 L
adaptor piece to hydraulic system 10 L

Adaptateurs machine/buse | Machine-/Nozzle Adapter

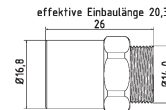
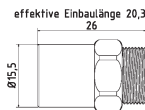
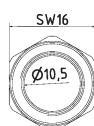
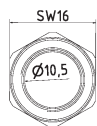

1-AD-I121-Typ1

Raccord adaptateur M12 x 1 filetage femelle sur filetage mâle Hirt-Line Typ1
adaptor piece M12 x 1 female thread to Hirt-Line type1 male thread

1-AD-I121.5-Typ1

Raccord adaptateur M12 x 1,5 filetage femelle sur filetage mâle Hirt-Line Typ1
adaptor piece M12 x 1.5 female thread to Hirt-Line type1 male thread

1-AD-I141.5-Typ1

Raccord adaptateur M14 x 1,5 filetage femelle sur filetage mâle Hirt-Line Typ1
adaptor piece M14 x 1.5 female thread to Hirt-Line type1 male thread

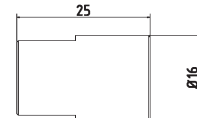
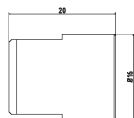
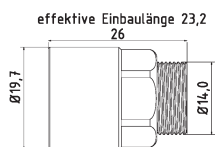
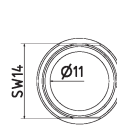
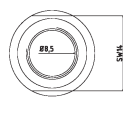
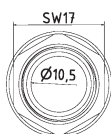

1-AD-I161.5-Typ1

Raccord adaptateur M16 x 1,5 filetage femelle sur filetage mâle Hirt-Line Typ1
adaptor piece M16 x 1.5 female thread to Hirt-Line type1 male thread

1-AD-1GE-18

Raccord adaptateur pour buses étrangères avec filetage mâle, filetage femelle 1-GE sur femelle 1/8"
adapter piece for external nozzles with male thread, female 1-GE to female 1/8"

1-AD-1GE-14

Raccord adaptateur pour buses étrangères avec filetage mâle, filetage femelle 1-GE sur femelle 1/4"
adapter piece for external nozzles with male thread, female 1-GE to female 1/4"

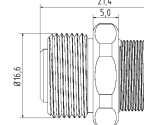
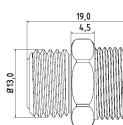
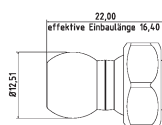
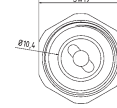
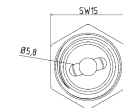

1-AD-LL

Raccord adaptateur Loc-Line Typ 1
adaptor piece Loc-Line Type 1

1-AD-RSV-14

Raccord adaptateur filetage avec clapet anti-retour G1/4"
adapter piece with check valve G1/4"

1-AD-RSV-38

Raccord adaptateur filetage avec clapet anti-retour G3/8"
adapter piece with check valve G3/8"

Typ1 [Système 1/4"]

Éléments coudés | Elbows

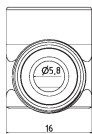

1-WV-1

Raccord coudé à visser
elbow piece fixed

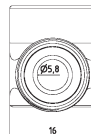

1-WV-2

Raccord en T à visser
T-piece fixed

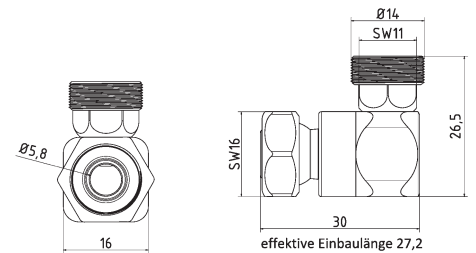

1-WV-1K

Raccord coudé à rotule
elbow piece moveable

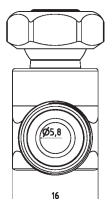
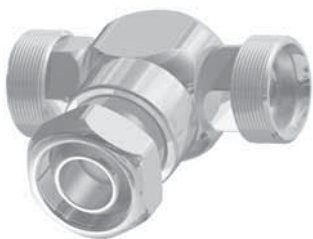

1-WV-2K

Raccord en T avec rotule
T-piece moveable

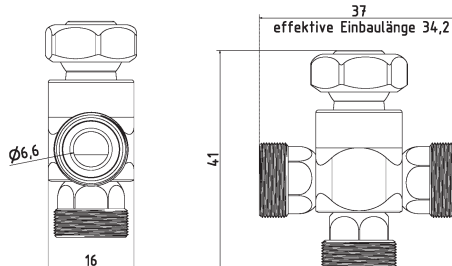

1-WV-3K

Connecteur en croix avec rotule
cross piece moveable

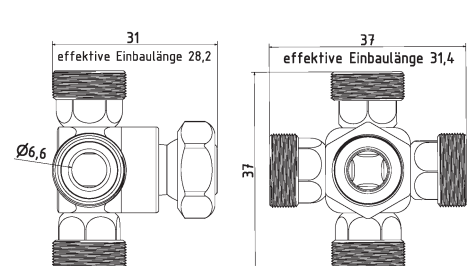

1-WV-4K

Raccord en étoile avec rotule
star piece moveable

Éléments coudés | Elbows

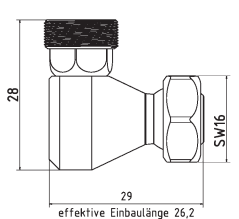
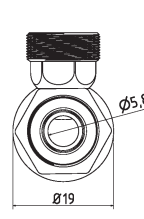
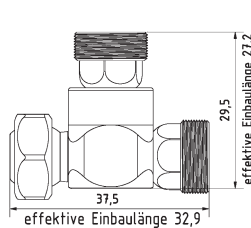
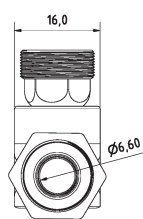
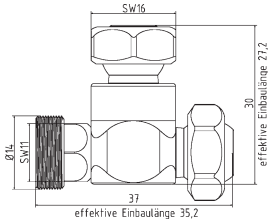
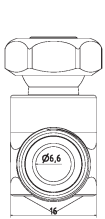

1-WV-R

Raccord obturateur pour buse annulaire
locking tappet to ring nozzle

1-WV-R-2K

Raccord en T pour bague et buse
T-piece for ring and nozzle

1-WI

Raccord coudé pour conduites
corner piece for pipelines

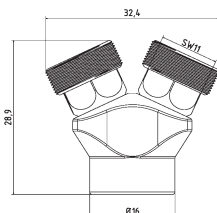
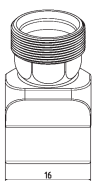

1-YV

Raccord en Y 50°
Y-piece 50°



Buses | Nozzles

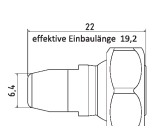
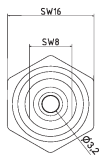
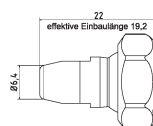
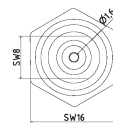
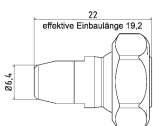
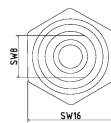

1-DU-0

Buse sans perçage
nozzle straight without drilling

1-DU-16

Buse à jet rectiligne perçage Ø 1,6 mm
nozzle straight Ø 1,6 mm

1-DU-32

Buse à jet rectiligne perçage Ø 3,2 mm
nozzle straight Ø 3,2 mm

Typ1 [Système 1/4"]

Buses | Nozzles

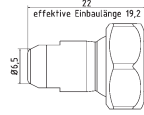
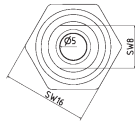

1-DU-50

Buse à jet rectiligne perçage Ø 5,0 mm
nozzle straight Ø 5,0 mm

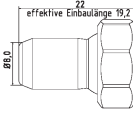
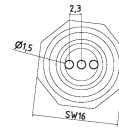

1-DU-3-16

Buse à jet rectiligne perçage 3 x Ø 1,6 mm
nozzle straight 3 x Ø 1,6 mm

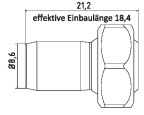
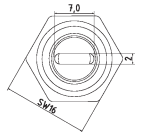

1-DU-72

Buse avec fente 7 x 2,0 mm
nozzle straight with slit 7 x 2,0 mm

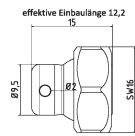

1-DU-90-1

Buse jet 90° perçage 1 x Ø 2 mm
nozzle 90° drill hole 1 x Ø 2 mm

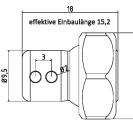

1-DU-90-2

Buse jet 90° perçage 2 x Ø 2 mm
nozzle 90° drill hole 2 x Ø 2 mm

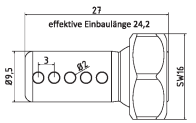

1-DU-90-5

Buse jet 90° perçage 5 x Ø 2 mm
nozzle 90° drill hole 5 x Ø 2 mm

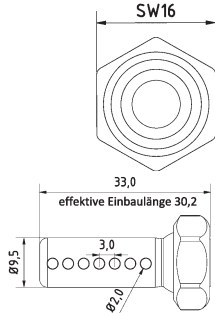
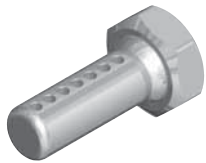

1-DU-90-7

Buse jet 90° perçage 7 x Ø 2 mm
nozzle 90° drill hole 7 x Ø 2 mm

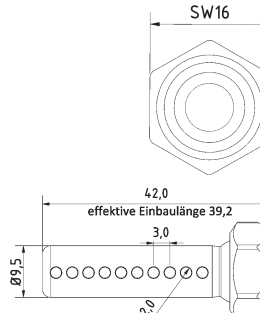

1-DU-90-10

Buse jet 90° perçage 10 x Ø 2 mm
nozzle 90° drill hole 10 x Ø 2 mm

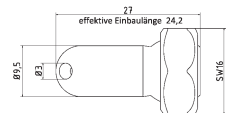

1-DU-30

Buse jet 30° perçage Ø 3 mm
nozzle 30° drill hole Ø 3 mm

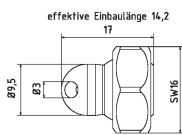
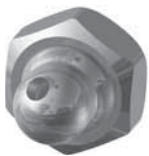

1-DU-30-EK

Buse jet 30° perçage Ø 3 mm extra court
nozzle 30° drill hole Ø 3 mm extra short

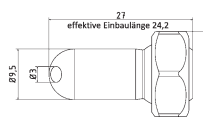

1-DU-60

Buse jet 60° perçage Ø 3 mm
nozzle 60° drill hole Ø 3 mm

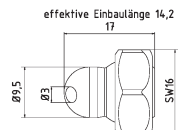

1-DU-60-EK

Buse jet 60° perçage Ø 3 mm extra court
nozzle 60° drill hole Ø 3 mm extra short

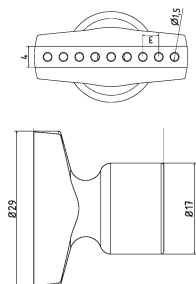

1-DU-BL

Buse jet large perçage 9 x Ø 1,5 mm
nozzle broadly with drillings 9 x Ø 1,5 mm

Buses | Nozzles

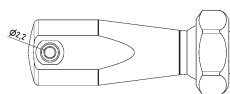
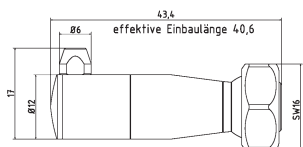

1-HA-DU

Support de buse, petit L. = 40, y compris 3 buses
small nozzle holder l = 40 incl. 3 nozzles

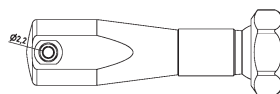
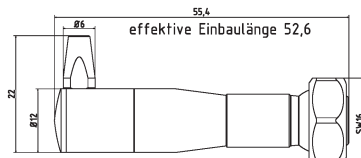
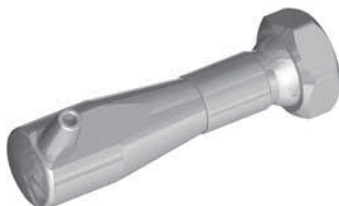

1-HA-DU-2

Support de buse, petit L. = 55, y compris 3 buses
small nozzle holder l = 55 incl. 3 nozzles

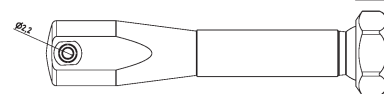
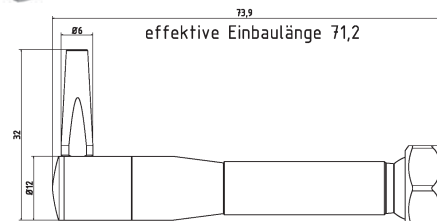
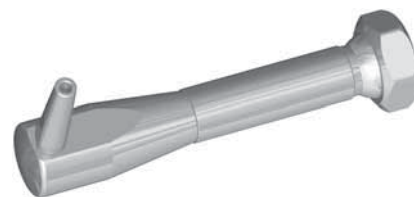

1-HA-DU-3

Support de buse, petit L. = 70, y compris 3 buses
small nozzle holder l = 70 incl. 3 nozzles

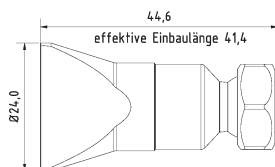
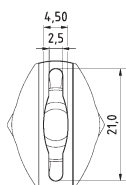

1-DU-SL-SS

Buse plate large avec fente 21 x 2,5 mm
à jet de dispersion
flat nozzle broadly with slit 21 x 2,5 mm
scattered beam

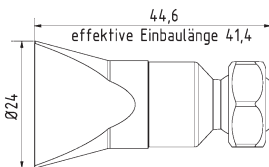
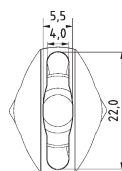

1-DU-SL-25

Buse plate large avec fente 22 x 4,0 mm
à jet de dispersion
flat nozzle broadly with slit 22 x 4,0 mm
scattered beam

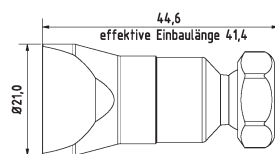
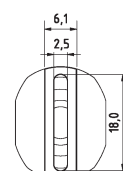

1-DU-SL-GS

Buse plate large avec fente 18 x 2,5 mm
jet rectiligne
flat nozzle broadly with slit 18 x 2,5 mm
straight jet

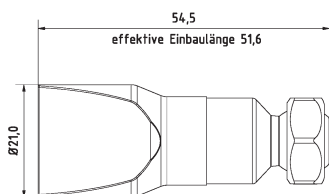
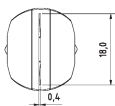

1-DU-SL-25-GS-0.4

Buse plate large avec fente 18 x 0,4 mm
jet rectiligne
flat nozzle broadly with slit 18 x 0,4 mm
straight jet

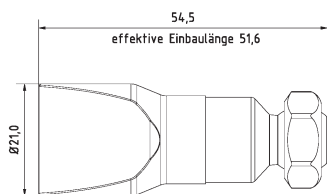
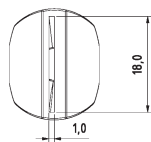

1-DU-SL-25-GS-1.0

Buse plate large avec fente 18 x 1,0 mm
jet rectiligne
flat nozzle broadly with slit 18 x 1,0 mm
straight jet

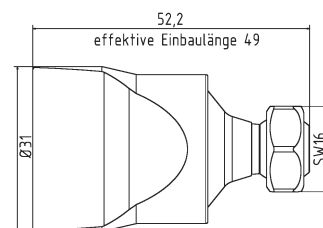
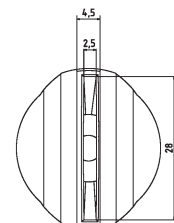

1-DU-SL-31-GS

Buse plate large avec fente 28 x 2,5 mm
jet rectiligne
flat nozzle broadly with slit 28 x 2,5 mm
straight jet

Typ1 [Système 1/4"]

Buses | Nozzles

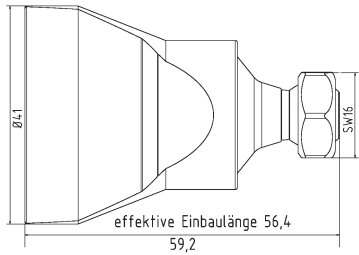
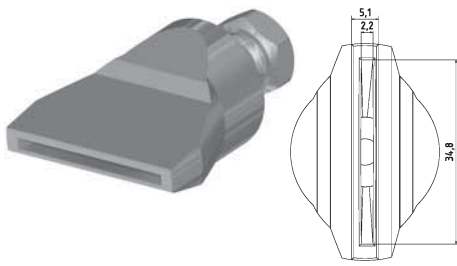

1-DU-SL-50-GS

Buse fente largeur 35 x 2,2 mm
jet rectiligne
*flat nozzle broadly with slit 35 x 2,2 mm
straight jet*

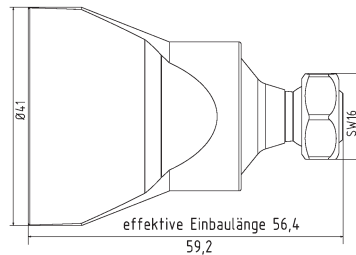
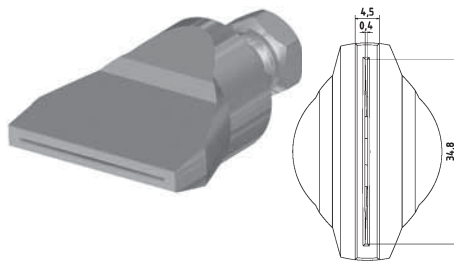

1-DU-SL-50-GS-0.4

Buse fente largeur 35 x 0,4 mm
jet rectiligne
*flat nozzle broadly with slit 35 x 0,4 mm
straight jet*

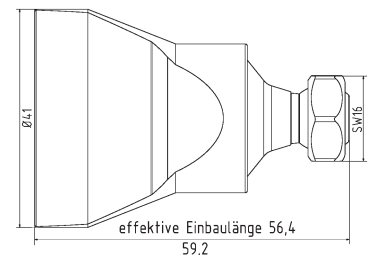
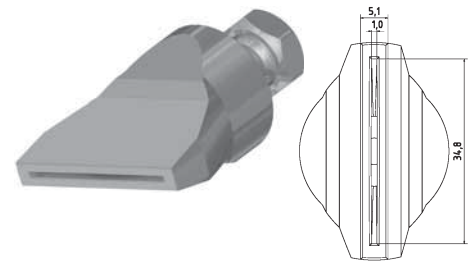

1-DU-SL-50-GS-1.0

Buse fente largeur 35 x 1,0 mm
jet rectiligne
*flat nozzle broadly with slit 35 x 1,0 mm
straight jet*

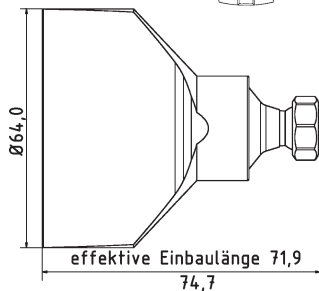
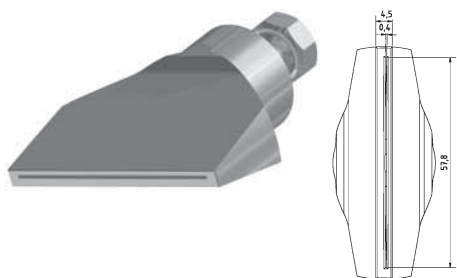

1-DU-SL-65-GS-0.4

Buse fente largeur 58 x 0,4 mm jet rectiligne
*flat nozzle broadly with slit 58 x 0,4 mm
straight jet*

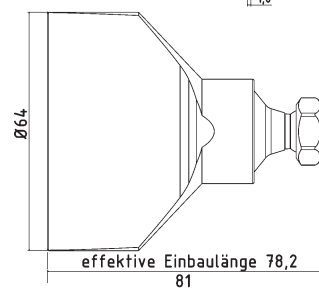
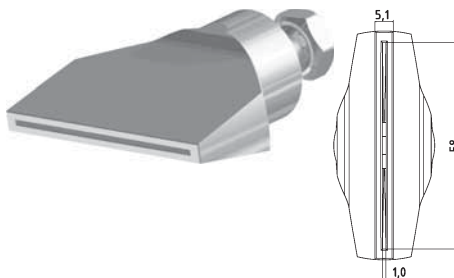

1-DU-SL-65-GS-1.0

Buse fente largeur 58 x 1,0 mm jet rectiligne
*flat nozzle broadly with slit 58 x 1,0 mm
straight jet*

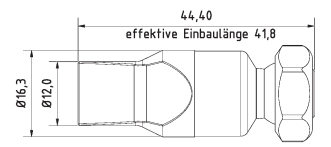

1-DU-LL-5-15

Buse jet rectiligne perçage 5 x Ø 1,5 mm
nozzle straight drill hole 5 x Ø 1,5 mm

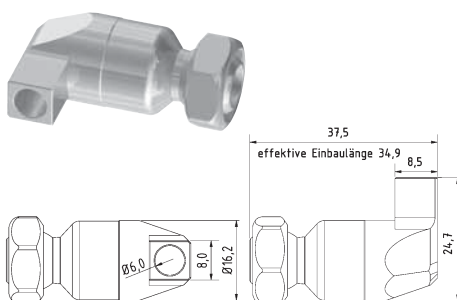

1-DU-LL-90-1-6

Buse jet 90° perçage 1 x Ø 6 mm
nozzle 90° drill hole 1 x Ø 6 mm

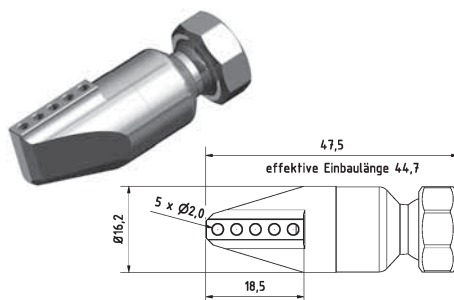

1-DU-LL-90-5-2

Buse jet 90° perçage 5 x Ø 2 mm
nozzle 90° drill hole 5 x Ø 2 mm

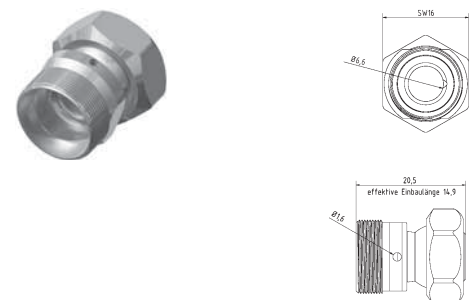

1-DU-R

Élément buse annulaire perçage Ø 1,6 mm
ring nozzle element drill hole Ø 1,6 mm

Buses et supports | Nozzles and Holder

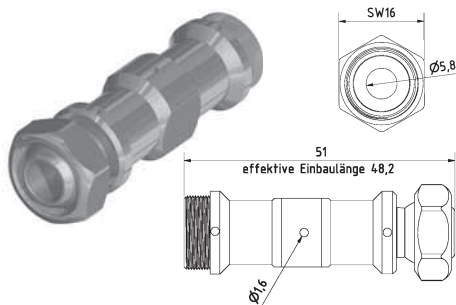

1-DU-EL3

Élément d'arrosage avec perçage 3 x Ø 1,6 mm
shower element drillings 3 x Ø 1,6 mm

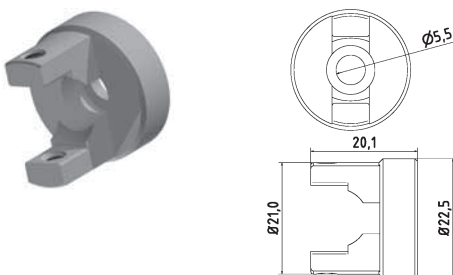

1-DU-ELH

Support pour élément d'arrosage (visserie comprise)
holder to shower element (incl. Screws)

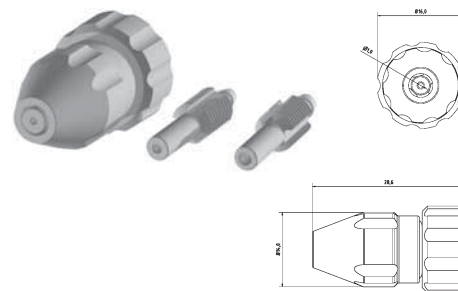

1-DU-Mini

Kit de buses pour système de lubrification
minimum pour tuyau 2 mm, 2,5 mm et 3 mm
nozzle minimum lubrication system set
for 2 mm, 2,5 mm and 3 mm pipe

Buses plastique | Plastic Nozzles

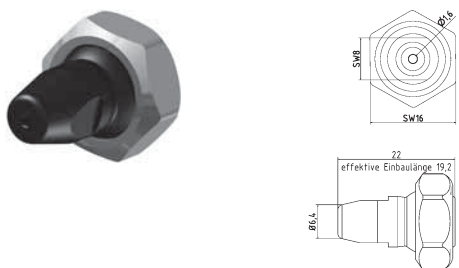

KU-1-DU-16

Buse plastique jet rectiligne perçage Ø 1,6 mm
plastic nozzle straight Ø 1,6 mm

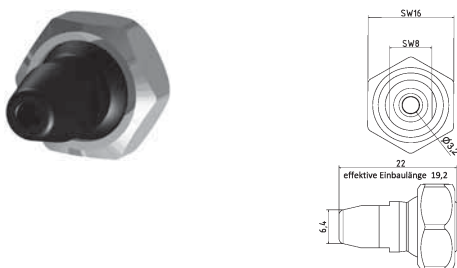

KU-1-DU-32

Buse plastique jet rectiligne perçage Ø 3,2 mm
plastic nozzle straight Ø 3,2 mm

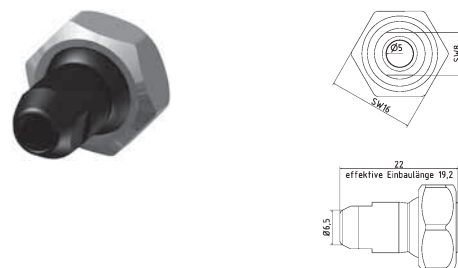

KU-1-DU-50

Buse plastique jet rectiligne perçage Ø 5,0 mm
plastic nozzle straight Ø 5,0 mm

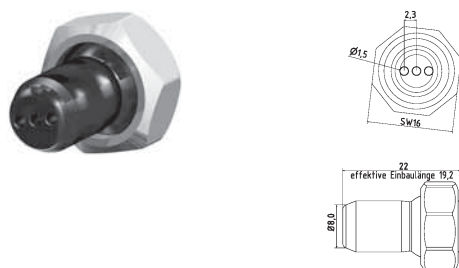

KU-1-DU-3-16

Buse plastique jet rectiligne perçage 3 x Ø 1,6 mm
plastic nozzle straight 3 x Ø 1,6 mm

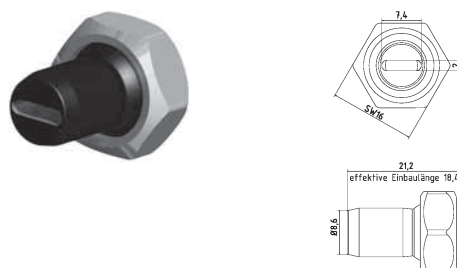

KU-1-DU-72

Buse plastique avec fente 7 x 2,0 mm
plastic nozzle straight with slit 7 x 2,0 mm

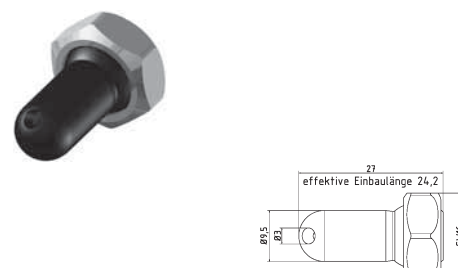

KU-1-DU-30

Buse plastique jet 30° perçage Ø 3 mm
plastic nozzle 30° drill hole Ø 3 mm

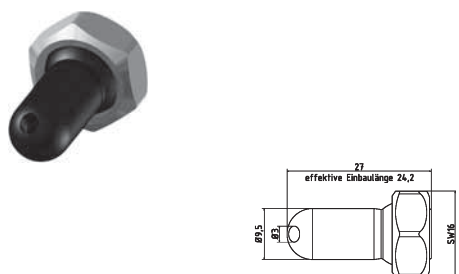

KU-1-DU-60

Buse plastique jet 60° perçage Ø 3 mm
plastic nozzle 60° drill hole Ø 3 mm

Typ1 [Système 1/4"]

Buse à bille | Ball Buse

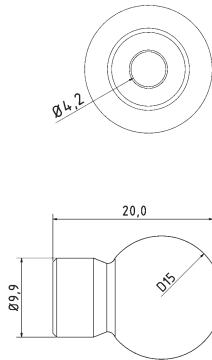

1-DU-K15-4.2

Buse pour porte-outil
alésage droit \varnothing 4,2mm boule \varnothing 15mm
Nozzle for tool holder
straight bore \varnothing 4.2mm ball \varnothing 15mm

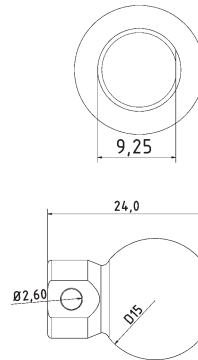

1-DU-K15-90-2.6

Buse pour porte-outil 90° alésage
 \varnothing 2,6mm boule \varnothing 15mm
Nozzle for tool holder 90° bore \varnothing 2.6mm
ball \varnothing 15mm

Accessoires | Accessories

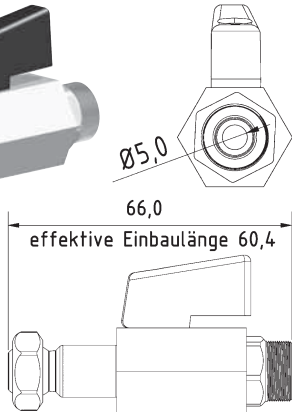
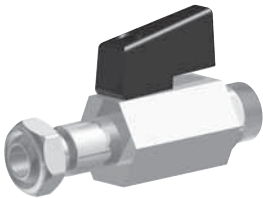

1-KH-Z

Vanne à bille élément intermédiaire Typ1
ball valve intermediate element type1

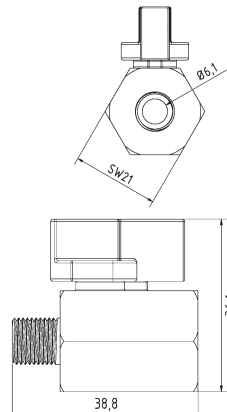
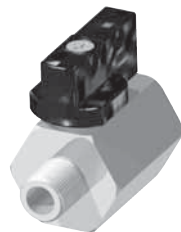

KH-18

Mini-robinet à rotule filetage 1/8", laiton chromé
mini ball valve thread 1/8" brass chrome-plated

KH-18-SS

Mini-robinet à rotule filetage 1/8", acier inoxydable
mini ball valve thread 1/8" stainless steel

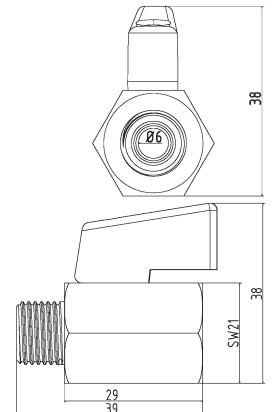

KH-14

Mini-robinet à rotule filetage 1/4", laiton chromé
mini ball valve thread 1/4" brass chrome-plated

KH-14-SS

Mini-robinet à rotule filetage 1/4", acier inoxydable
mini ball valve thread 1/4" stainless steel

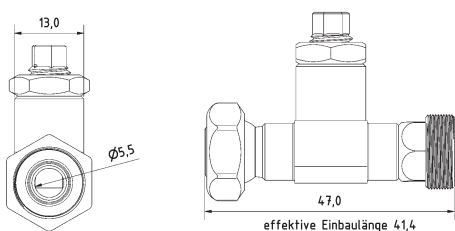
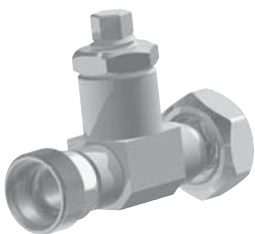

1-DRV

Vanne d'étranglement Typ1
throttle valve type1

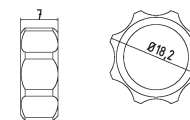

1-MU-HA

Écrou pour commande manuelle
screw nut (hand feed)

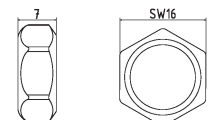
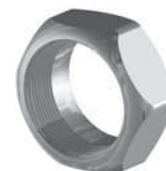

1-MU

Écrou standard
screw nut (default)

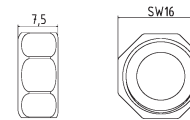
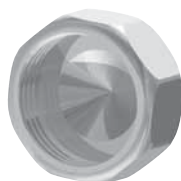

1-VK

Capuchon de fermeture Typ1
cap type 1

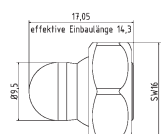
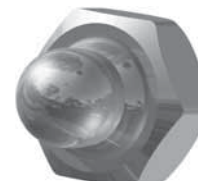

1-VER

Bouchon obturateur avec écrou pour élément arrosage
seal plug with screw nut for schowerelement

Accessoires | Accessories

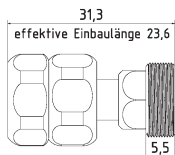
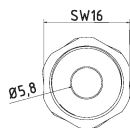

1-FP

Élément intermédiaire avec position fixe
(raccord rapide)

*Intermediate element with fixed position
(quick coupling)*



SW-11

Clé plate en acier SW11
open end wrench SW11



SW-16

Clé plate en acier SW16
open end wrench SW16

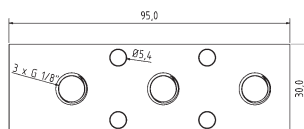
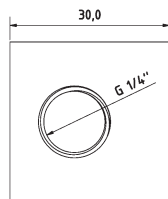

VB-3-18

Bloc distributeur entrée frontale filetage 1/4"
manifold block entrance front end 1/4"

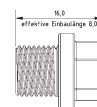
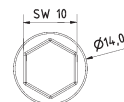

VB-3-18-BS

Bouchon obturateur avec filetage 1/8"
blank plug with thread 1/8"

Kit de base | Basic Set

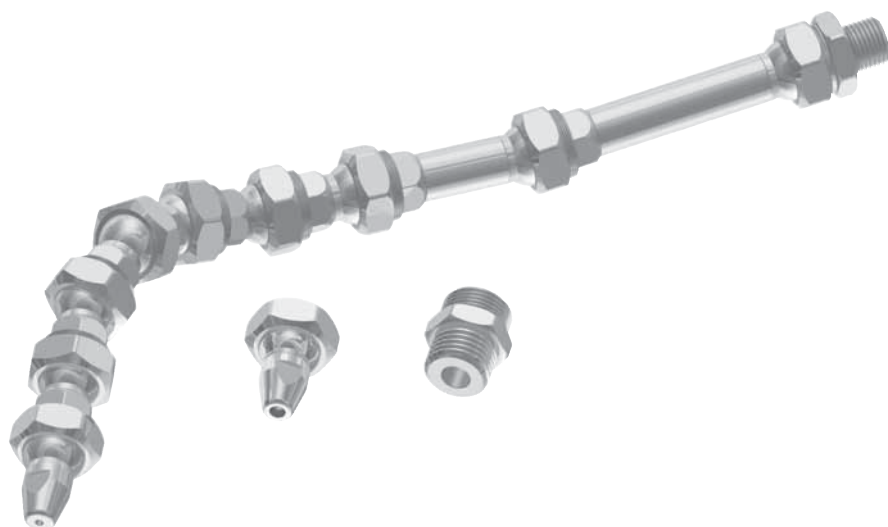

1-GS

Kit de base Typ1 Système 1/4" L. = 230 mm

6 x 1-GE, 1 x 1-GE-2, 1 x 1-GE-3, 1 x 1-AD-18, 1 x 1-AD-14, 1 x 1-DU-16, 1 x 1-DU-32

basic set Type1 1/4" system l = 230 mm:

6 x 1-GE, 1 x 1-GE-2, 1 x 1-GE-3, 1 x 1-AD-18, 1 x 1-AD-14, 1 x 1-DU-16, 1 x 1-DU-32



1-GS-R

Kit buses annulaires (17 x 1-DU-R + 1 x 1-WV-R)

Ø = 80 mm extensible

ring nozzle set (17 x 1-DU-R + 1 x 1-WV-R)

Ø = 80 mm expendable

VUE D'ENSEMBLE DES PRODUITS

Typ2 [1/2"]



Avec le système Typ2, vos processus machine sont optimisés de $\pm 12\%$. Utilisez la diversité de l'assortiment de buses et adaptez le refroidissement à vos besoins. Qu'il s'agisse de buses plates, de buses rondes ou de buses à plusieurs orifices de sortie pour la rectifieuses, le tournage, le fraisage ou le refroidissement d'air, vous trouvez les éléments appropriés dans le système Typ2. Les éléments de base et les adaptateurs machine du système Typ2 présentent une gamme complète d'éléments, qui vous donnent l'assurance d'optimiser l'usure des outils et la garantie d'un refroidissement stable.

DONNÉES TECHNIQUES:

- Taille Typ2 (1/2")
- Section de passage Ø 11,0 mm
- Résistance à la pression au delà de 100 bars
- Champ d'utiisation -30° C jusqu'à +60° C
- En option, système ES extra robuste jusqu'à + 300° C (disponible sur demande)
- Filetage (éléments) M24 x 1,25
- Matériau 1.4305 (V2A)

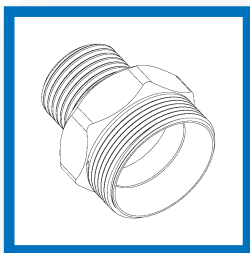
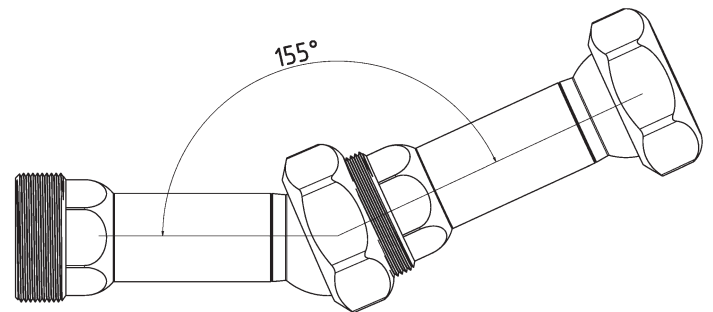
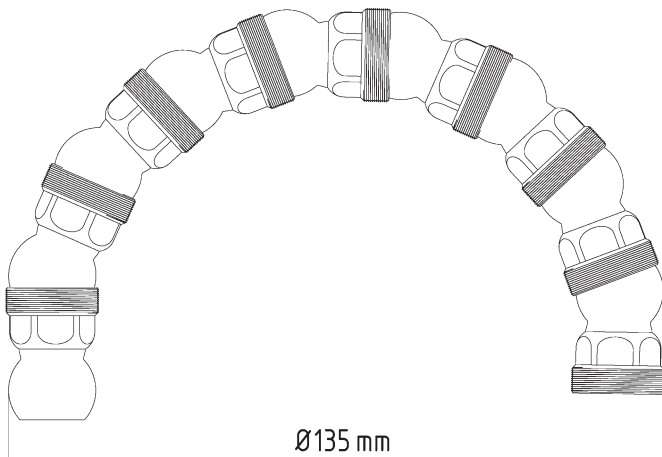

ADAPTATEURS MACHINE

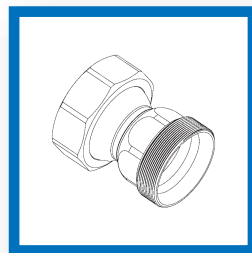

ÉLÉMENTS DE BASE

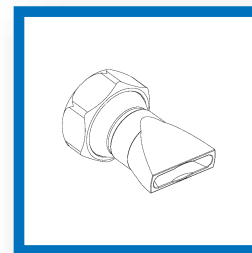

BUSES

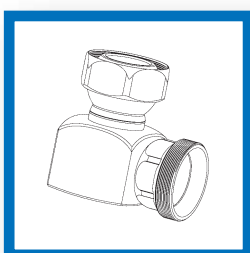

ÉLÉMENTS COUDÉS

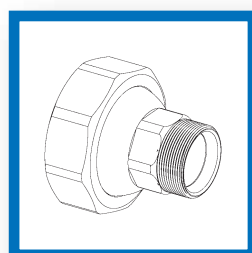

ACCESSOIRES

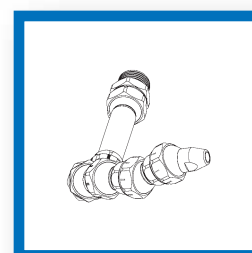

ACCESSOIRES Typ2

Typ2 [Système 1/2"]

Éléments de base | Basic Elements

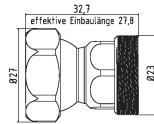
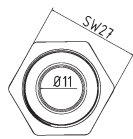

2-GE

L. = 32,7 mm | L. effective = 27,8 mm
l = 32,7 mm effective l = 27,8 mm

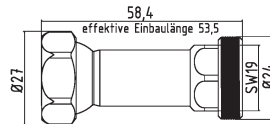
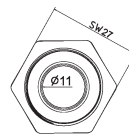

2-GE-2

L. = 58,4 mm | L. effective = 53,5 mm
l = 58,4 mm effective l = 53,5 mm

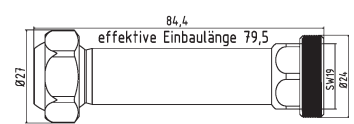
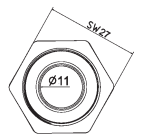

2-GE-3

L. = 84,4 mm | L. effective = 79,5 mm
l = 84,4 mm effective l = 79,5 mm

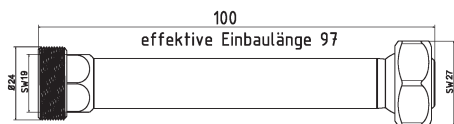
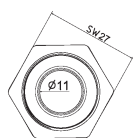

2-GE-100

L. = 100 mm | L. effective = 97 mm
l = 100 mm effective l = 97 mm

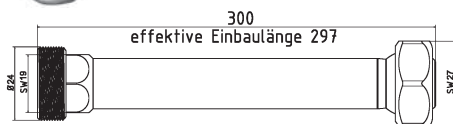
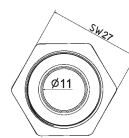

2-GE-300

L. = 300 mm | L. effective = 297 mm
l = 300 mm effective l = 297 mm

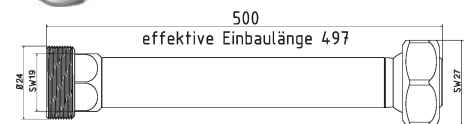
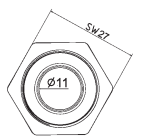

2-GE-500

L. = 500 mm | L. effective = 497 mm
l = 500 mm effective l = 497 mm

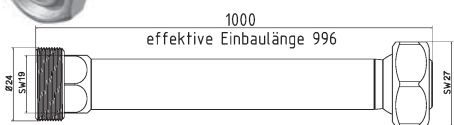
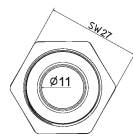

2-GE-1000

L. = 1000 mm | L. effective = 996 mm
l = 1000 mm effective l = 996 mm

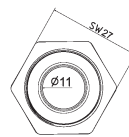

2-GE-DK Élément spécial

L. = 35,5 mm | L. effective = 22,8 mm double rotule
l = 35,5 mm effective l = 22,8 mm double ball

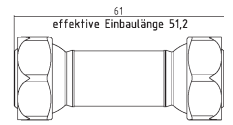
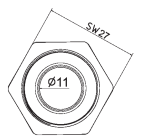

2-GE-2-DK Élément spécial

L. = 61 mm | L. effective = 51,2 mm double rotule
l = 61 mm effective l = 51,2 mm double ball

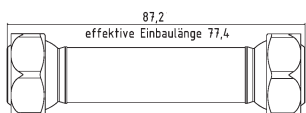
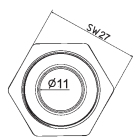

2-GE-3-DK Élément spécial

L. = 87,2 mm | L. effective = 77,4 mm double rotule
l = 87,2 mm effective l = 77,4 mm double ball

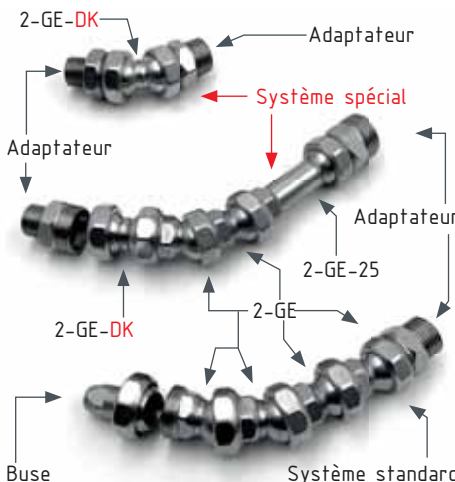

Adaptateurs machine/buse | Machine-/Nozzle Adapter

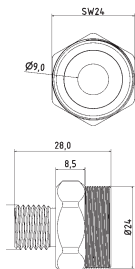

2-AD-14

Raccord adaptateur filetage 1/4"
adaptor piece thread 1/4"

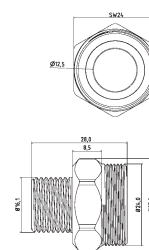
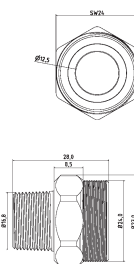
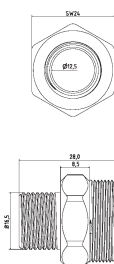

2-AD-38

Raccord adaptateur filetage 3/8"
adaptor piece thread 3/8"

2-AD-38-PT

Raccord adaptateur filetage 3/8" PT (filetage NPT)
adaptor piece thread 3/8" PT (NPT thread)

2-AD-38-U

Raccord adaptateur filetage 3/8" U (filetage avec gorge)
adaptor piece thread 3/8" U (Undercut thread)

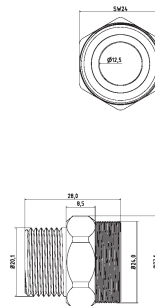
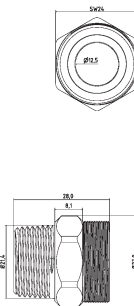
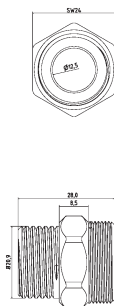

2-AD-12

Raccord adaptateur filetage 1/2"
adaptor piece thread 1/2"

2-AD-12-PT

Raccord adaptateur filetage 1/2" PT (filetage NPT)
adaptor piece thread 1/2" PT (NPT thread)

2-AD-12-U

Raccord adaptateur filetage 1/2" U (filetage avec gorge)
adaptor piece thread 1/2" U (Undercut thread)

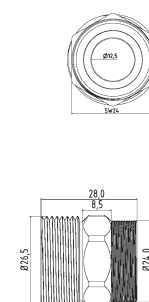
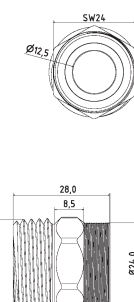

2-AD-34

Raccord adaptateur filetage 3/4"
adaptor piece thread 3/4"

2-AD-34-PT

Raccord adaptateur filetage 3/4" PT (filetage NPT)
adaptor piece thread 3/4" PT (NPT thread)

2-AD-34-U

Raccord adaptateur filetage 3/4" U (filetage avec gorge)
adaptor piece thread 3/4" U (Undercut thread)

Typ2 [Système 1/2"]

Adaptateurs machine/buse | Machine-/Nozzle Adapter

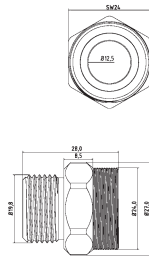

2-AD-201.5

Raccord adaptateur filetage M20 x 1.5"
adaptor piece thread M20 x 1.5"

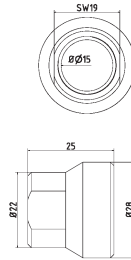

2-AD-2GE-38

Adaptateur pour buses étrangères avec filetage mâle, femelle 2-GE sur femelle 3/8"
adapter piece for external nozzles with male thread, female 2-GE to female 3/8"

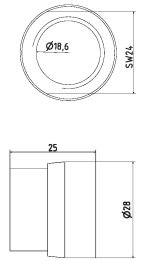

2-AD-2GE-12

Adaptateur pour buses étrangères avec filetage mâle, femelle 2-GE sur femelle 1/2"
adapter piece for external nozzles with male thread, female 2-GE to female 1/2"

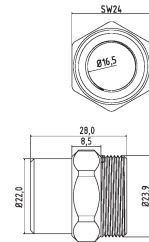

2-AD-I161.5-Typ2

Raccord adaptateur M16 x 1,5 filetage femelle sur filetage mâle Hirt-Line Typ2
adaptor piece M16 x 1.5 female thread to Hirt-Line type2 male thread

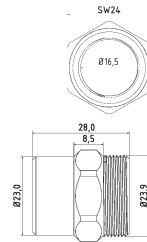

2-AD-I181.5-Typ2

Raccord adaptateur M18 x 1,5 filetage femelle sur filetage mâle Hirt-Line Typ2
adaptor piece M18 x 1.5 female thread to Hirt-Line type2 male thread

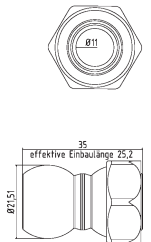

2-AD-LL

Raccord adaptateur Loc-Line Typ 2
adaptor piece Loc-Line Type 2

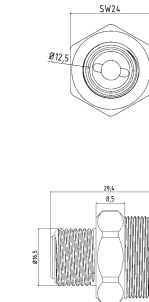

2-AD-RSV-38

Raccord adaptateur filetage avec clapet anti-retour G3/8"
adapter piece with check valve G3/8"

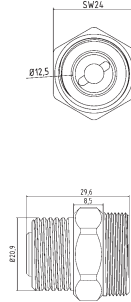

2-AD-RSV-12

Raccord adaptateur filetage avec clapet anti-retour G1/2"
adapter piece with check valve G1/2"

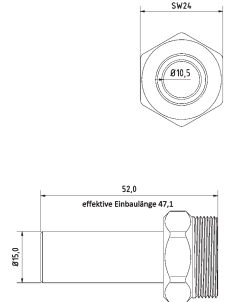

2-AD-15L

Raccord adaptateur pour raccord hydraulique 15 L
adaptor piece to hydraulic system 15 L

Éléments coulés | Elbows

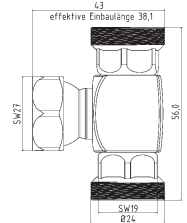
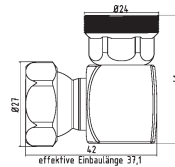
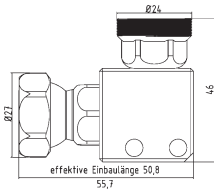
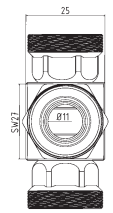
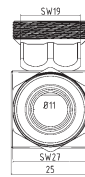
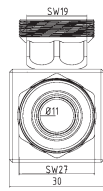

2-WI

Raccord coulé pour conduites avec 2 perçages
corner piece for pipelines with 2 bore hole

2-WV-1K

Raccord coulé
elbow piece

2-WV-2K

Raccord en T à visser
T-piece

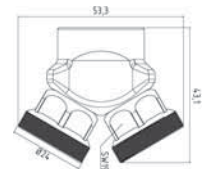
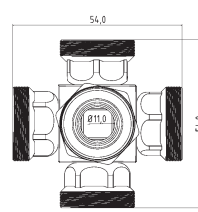
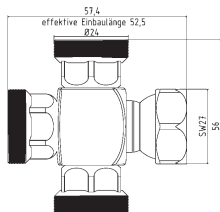
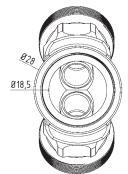
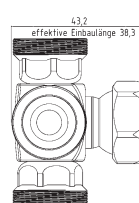
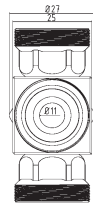
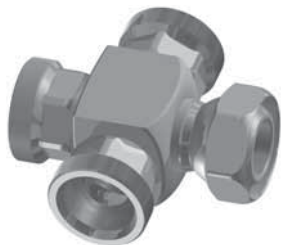

2-WV-3K

Raccord en croix
cross piece

2-WV-4K

Raccord en étoile
star piece

2-YV

Raccord en Y 50°
Y-piece 50°

Buses | Nozzles

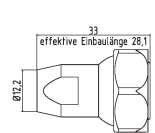
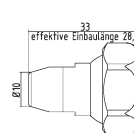
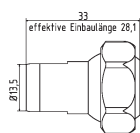
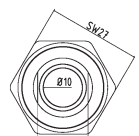
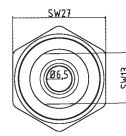
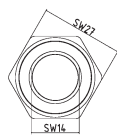

2-DU-0

Buse sans perçage (pour applications spéciales)
nozzle without hole (for special applications)

2-DU-65

Buse à jet rectiligne perçage Ø 6,5 mm
nozzle straight Ø 6,5 mm

2-DU-10

Buse à jet rectiligne perçage Ø 10 mm
nozzle straight Ø 10 mm

Typ2 [Système 1/2"]

Buses | Nozzles



2-DU-12

Buse à jet rectiligne perçage Ø 12 mm
nozzle straight Ø 12 mm

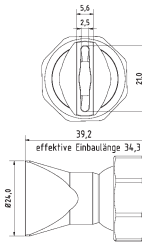

2-DU-SL-25-SS

Buse plate largeur fente 20 x 2,5 mm
à jet de dispersion
flat nozzle broadly with slit 20 x 2,5 mm
scattered beam

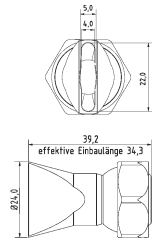

2-DU-SL-25

Buse plate largeur fente 22 x 4,0 mm
à jet de dispersion
flat nozzle broadly with slit 22 x 4,0 mm
scattered beam

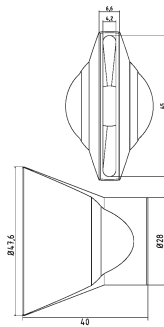
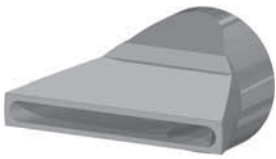

2-DU-SL-50

Buse plate largeur fente 45 x 4,2 mm
à jet de dispersion
flat nozzle broadly with slit 45 x 4,2 mm
scattered beam



2-DU-SL-25-GS

Buse plate largeur fente 18 x 2,5 mm
à jet rectiligne
flat nozzle broadly with slit 18 x 2,5 mm
straight jet

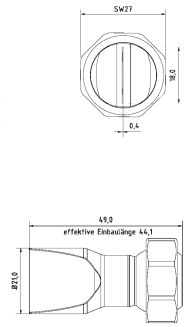

2-DU-SL-25-GS-0.4

Buse plate largeur fente 18 x 0,4 mm
à jet rectiligne
flat nozzle broadly with slit 18 x 0,4 mm
straight jet

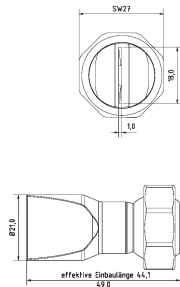

2-DU-SL-25-GS-1.0

Buse plate largeur fente 18 x 1,0 mm
à jet rectiligne
flat nozzle broadly with slit 18 x 1,0 mm
straight jet

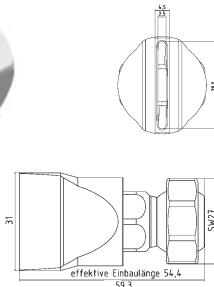

2-DU-SL-31-GS

Buse plate largeur fente 28 x 2,5 mm
à jet rectiligne
flat nozzle broadly with slit 28 x 2,5 mm
straight jet

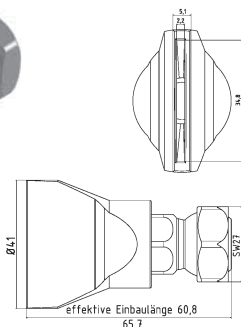

2-DU-SL-50-GS

Buse plate largeur fente 35 x 2,2 mm
à jet rectiligne
flat nozzle broadly with slit 35 x 2,2 mm
straight jet

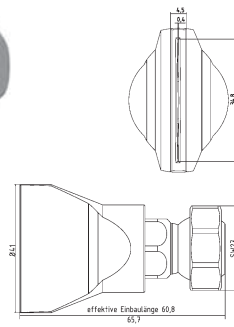
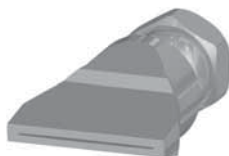

2-DU-SL-50-GS-0.4

Buse plate largeur fente 35 x 0,4 mm
à jet rectiligne
flat nozzle broadly with slit 35 x 0,4 mm
straight jet

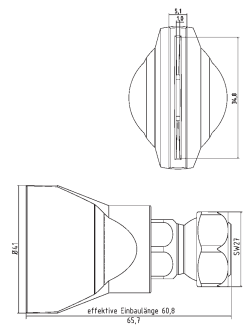

2-DU-SL-50-GS-1.0

Buse plate largeur fente 35 x 1,0 mm
à jet rectiligne
flat nozzle broadly with slit 35 x 1,0 mm
straight jet

Buses | Nozzles

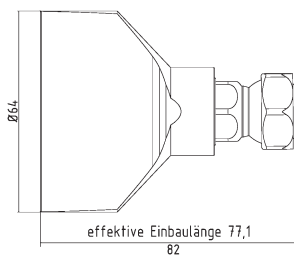
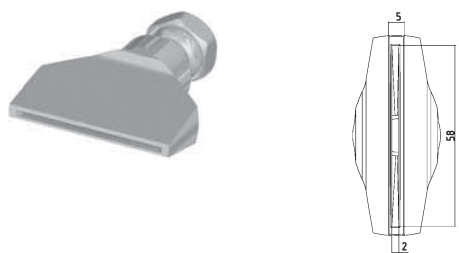

2-DU-SL-65-GS

Buse plate largeur fente 58 x 2,0 mm
à jet rectiligne

*flat nozzle broadly with slit 58 x 2,0 mm
straight jet*

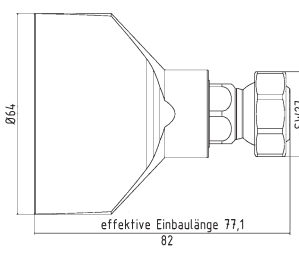
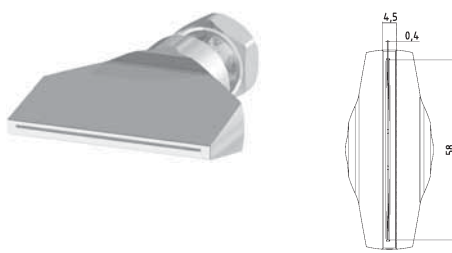

2-DU-SL-65-GS-0.4

Buse plate largeur fente 58 x 0,4 mm
à jet rectiligne

*flat nozzle broadly with slit 58 x 0,4 mm
straight jet*

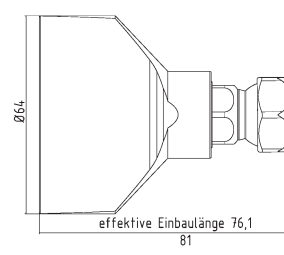
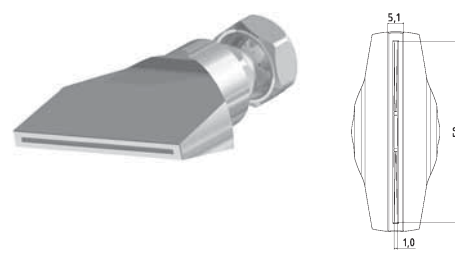

2-DU-SL-65-GS-1.0

Buse plate largeur fente 58 x 1,0 mm
à jet rectiligne

*flat nozzle broadly with slit 58 x 1,0 mm
straight jet*

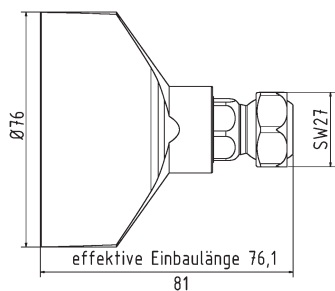
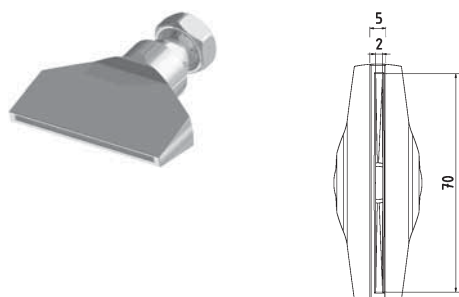

2-DU-SL-76-GS

Buse plate largeur fente 70 x 2,0 mm
à jet rectiligne

*flat nozzle broadly with slit 70 x 2,0 mm
straight jet*

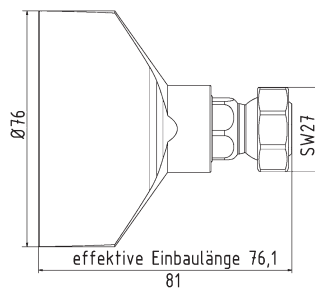
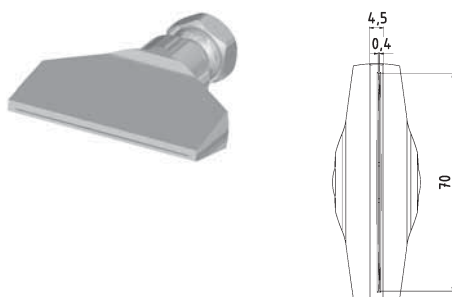

2-DU-SL-76-GS-0.4

Buse plate largeur fente 70 x 0,4 mm
à jet rectiligne

*flat nozzle broadly with slit 70 x 0,4 mm
straight jet*

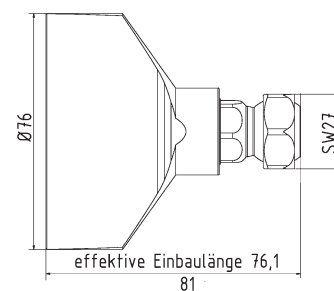
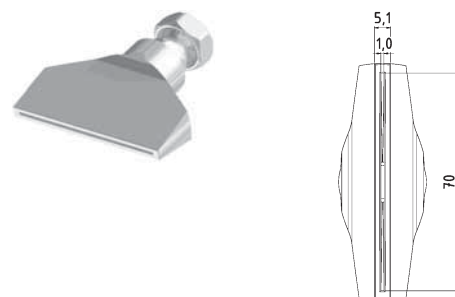

2-DU-SL-76-GS-1.0

Buse plate largeur fente 70 x 1,0 mm
à jet rectiligne

*flat nozzle broadly with slit 70 x 1,0 mm
straight jet*

Typ2 [Système 1/2"]

Buses | Nozzles

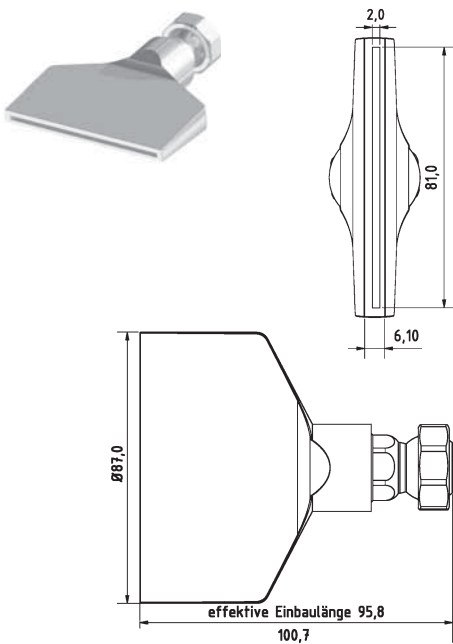

2-DU-SL-87-GS

Buse plate largeur fente 81 x 2,0 mm
à jet rectiligne
*flat nozzle broadly with slit 81 x 2,0 mm
straight jet*

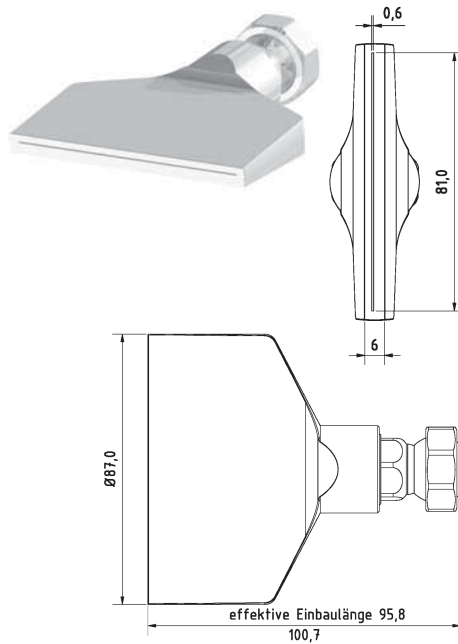

2-DU-SL-87-GS-0.6

Buse plate largeur fente 81 x 0,6 mm
à jet rectiligne
*flat nozzle broadly with slit 81 x 0,6 mm
straight jet*

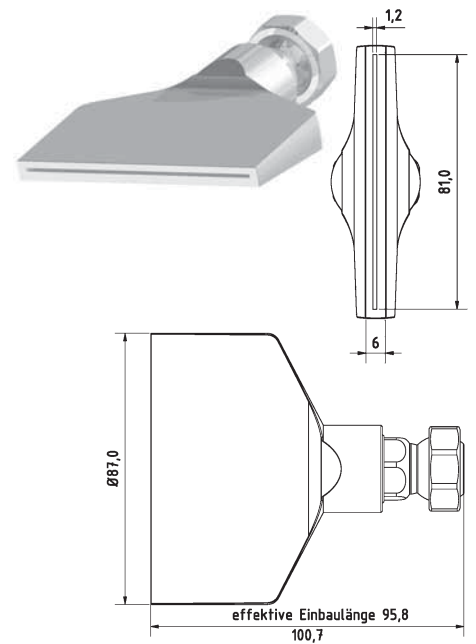

2-DU-SL-87-GS-1.2

Buse plate largeur fente 81 x 1,2 mm
à jet rectiligne
*flat nozzle broadly with slit 81 x 1,2 mm
straight jet*

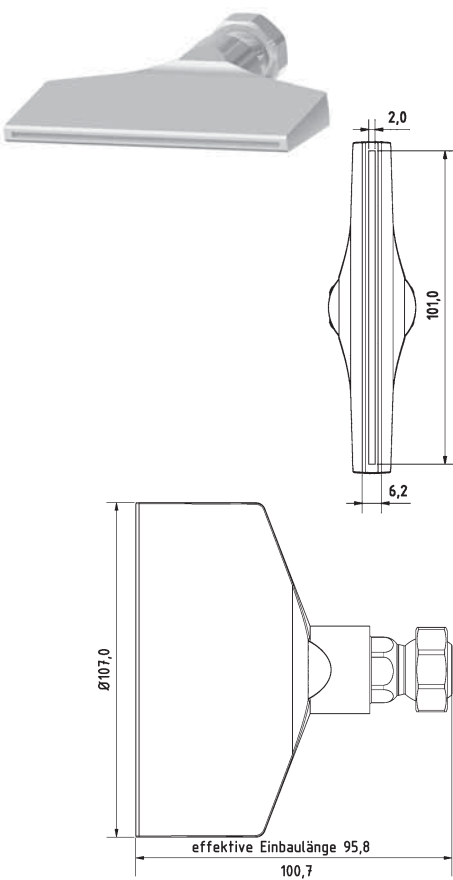

2-DU-SL-107-GS

Buse plate largeur fente 101 x 2,0 mm
à jet rectiligne
*flat nozzle broadly with slit 101 x 2,0 mm
straight jet*

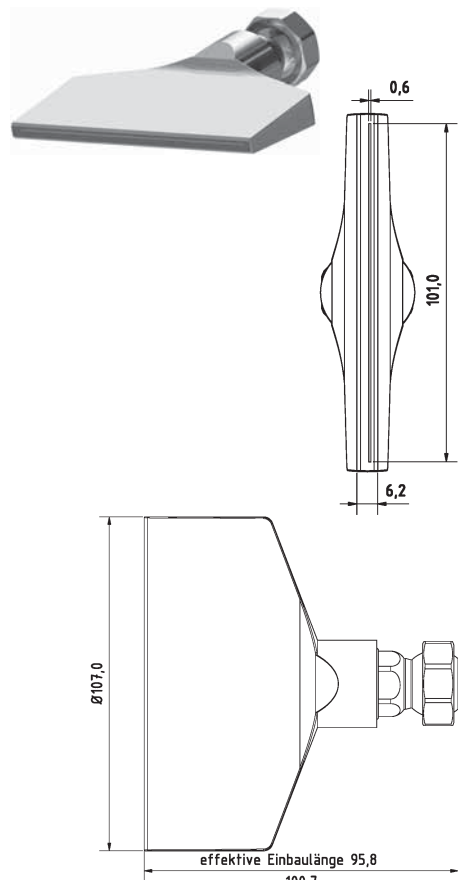

2-DU-SL-107-GS-0.6

Buse plate largeur fente 101 x 0,6 mm
à jet rectiligne
*flat nozzle broadly with slit 101 x 0,6 mm
straight jet*

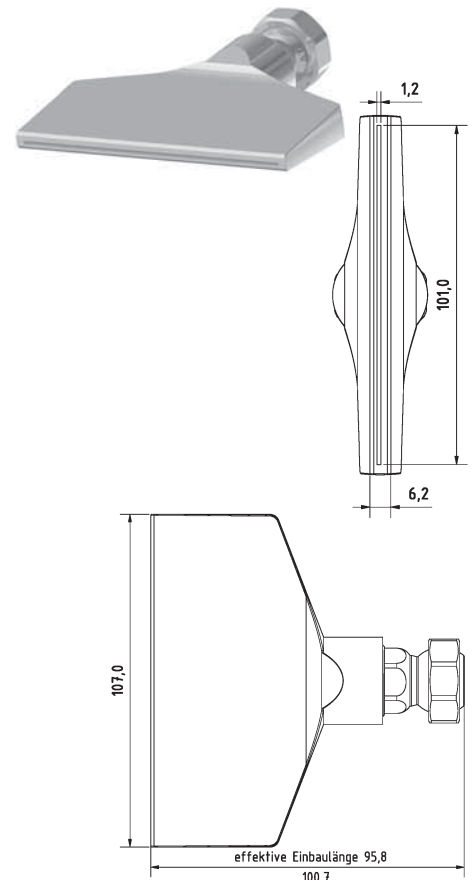

2-DU-SL-107-GS-1.2

Buse plate largeur fente 101 x 1,2 mm
à jet rectiligne
*flat nozzle broadly with slit 101 x 1,2 mm
straight jet*

Buses | Nozzles

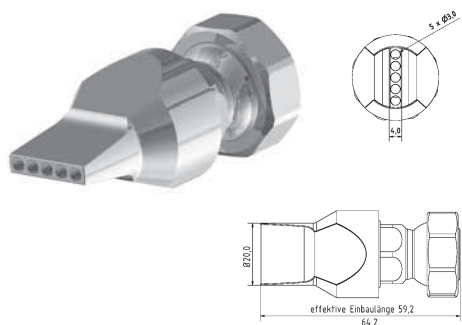

2-DU-LL-5-3

Buse à jet rectiligne perçage 5 x Ø 3 mm
nozzle straight drill holes 5 x Ø 3 mm

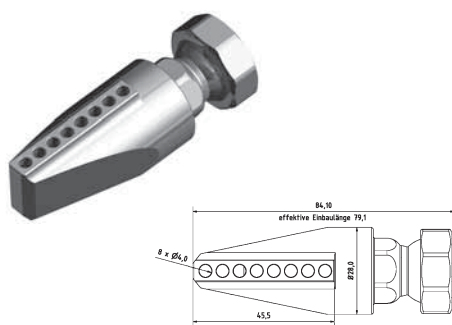

2-DU-LL-90-8

Buse à jet 90° perçage 8 x Ø 4 mm
nozzle 90° drill holes 8 x Ø 4 mm

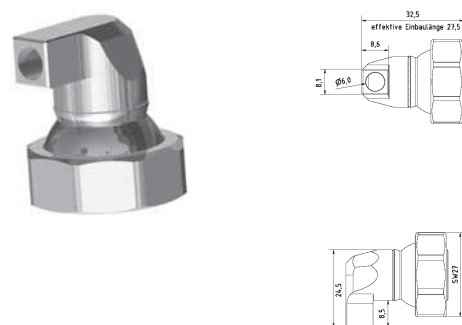

2-DU-LL-90-1-6

Buse à jet 90° perçage 1 x Ø 6 mm
nozzle 90° drill hole 1 x Ø 6 mm

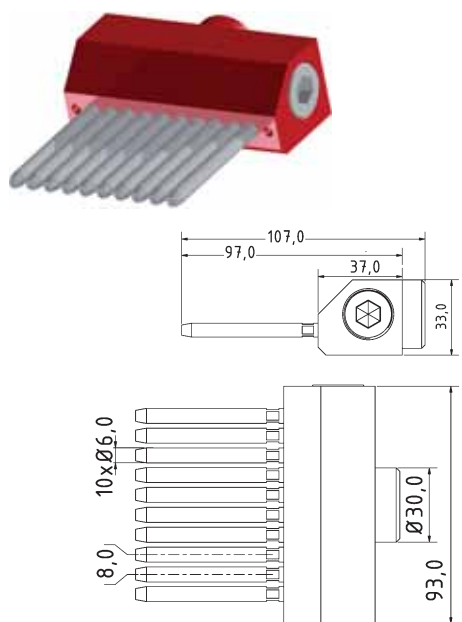

2-NA-DU-96

Buse à aiguille modulaire l = 96mm
incl. 10 aiguilles de votre choix l = 40-80mm
Modular Needle nozzle l = 96mm
incl. 10 needles of choice l = 40-80mm

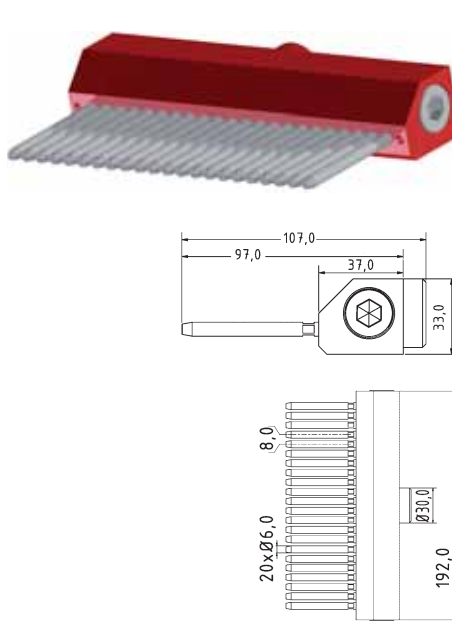

2-NA-DU-192

Buse à aiguille modulaire l = 192mm
incl. 22 aiguilles de votre choix l = 40-80mm
Modular Needle nozzle l = 192mm
incl. 22 needles of choice l = 40-80mm

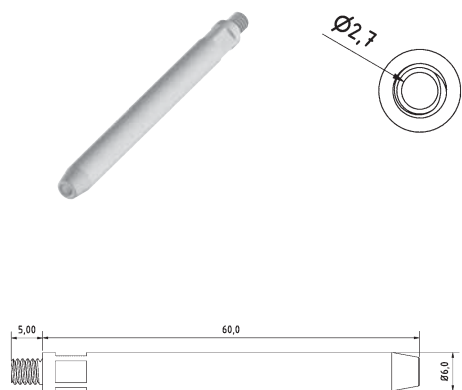

2-NA-Nadel

insert de buse simple / aiguille de rechange
l = 40/50/60/70/80mm
single nozzle insert / spare needle
l = 40/50/60/70/80mm



2-NA-ANB-SET

Jeu d'accessoires pour prolonger les buses à aiguilles selon les besoins
attachment set for extending the needle nozzles as required

Typ2 [Système 1/2"]

Buses plastiques | Plastic Nozzles

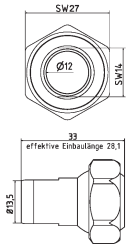
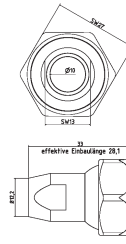
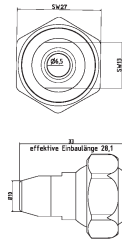

KU-2-DU-65

Buse plastique à jet rectiligne perçage Ø 6,5 mm
plastic nozzle straight Ø 6,5 mm

KU-2-DU-10

Buse plastique à jet rectiligne perçage Ø 10 mm
plastic nozzle straight Ø 10 mm

KU-2-DU-12

Buse plastique à jet rectiligne perçage Ø 12 mm
plastic nozzle straight Ø 12 mm

Accessoires | Accessories

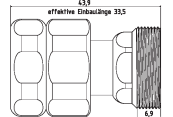
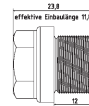
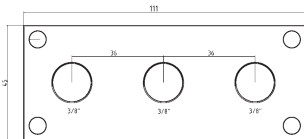
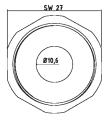
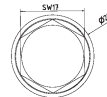
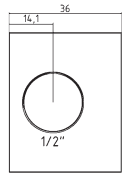
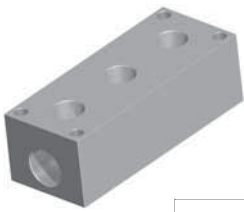

VB-3-38

Bloc distributeur entrée frontale filetage 1/2"
manifold block entrance front end 1/2"

VB-3-38-BS

Bouchon obturateur avec filetage 3/8"
blank plug with thread 3/8"

2-FP

Élément intermédiaire avec position fixe
(raccord rapide)
Intermediate element with fixed position
(quick coupling)

VB-3-38-PT

Bloc distributeur entrée frontale filetage 1/2" PT (NPT)
manifold block entrance front end 1/2" NPT

VB-3-38-PT-BS

Bouchon obturateur avec filetage 3/8" PT (NPT)
blank plug with thread 3/8" NPT

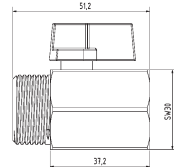
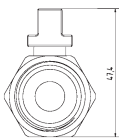
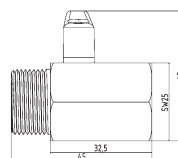
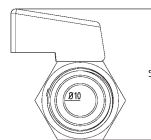
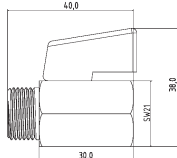
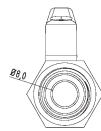

KH-38

Mini robinet à rotule filetage 3/8" laiton chromé
mini ball valve thread 3/8" brass chrome-plated

KH-12

Mini robinet à rotule filetage 1/2" laiton chromé
mini ball valve thread 1/2" brass chrome-plated

KH-34

Mini robinet à rotule filetage 3/4" laiton chromé
mini ball valve thread 3/4"

KH-38-SS

Mini robinet à rotule filetage 3/8" acier inoxydable
mini ball valve thread 3/8" stainless steel

KH-12-SS

Mini robinet à rotule filetage 1/2" acier inoxydable
mini ball valve thread 1/2" stainless steel

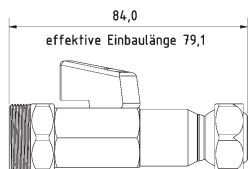
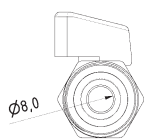
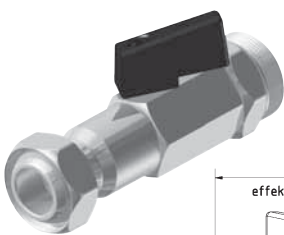

2-KH-Z

Vanne à bille élément intermédiaire Typ2
ball valve intermediate element type2

Accessoires | Accessories

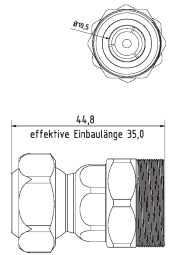
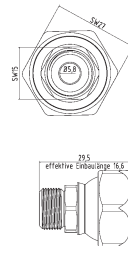
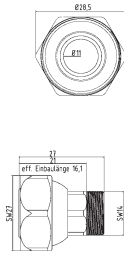

RE-2-1

Pièce de réduction Typ2 sur Typ1
reduction Type 2 to Type 1

RE-2-G1/4

Pièce de réduction Typ2 sur filetage 1/4"
reduction Type 2 to G 1/4"

2-RSV

Clapet anti-retour (drop stop/anti-goutte)
Check valve (Drop-Stop)

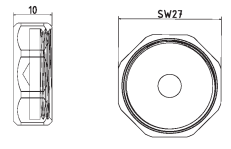
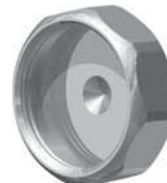
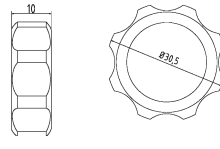
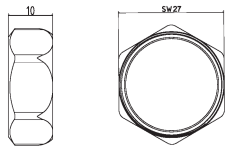

2-MU

Écrou standard
screw nut (default)

2-MU-HA

Écrou pour commande manuelle
screw nut (hand feed)

2-VK

Capuchon de fermeture Typ2
cap type 2

Kit de base | Basic Set



SW-19

Clé plate en acier SW19
open end wrench SW19



SW-27

Clé plate en acier SW27
open end wrench SW27

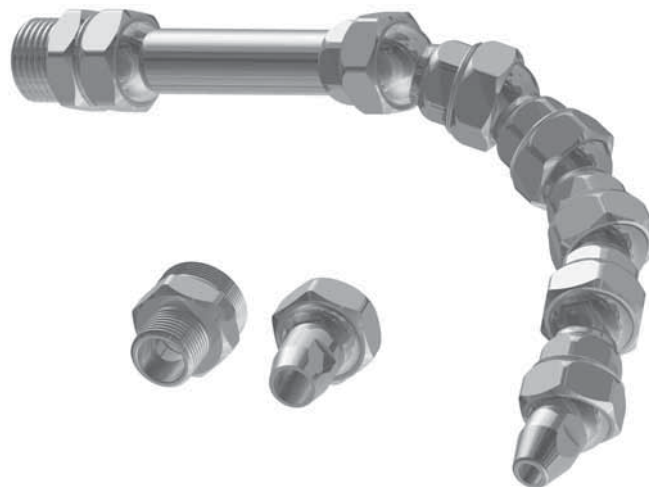

2-GS

Kit de base Typ2 Système filetage 1/2" L = 240 mm
5 x 2-GE, 1 x 2-GE-3, 1 x 2-AD-38, 1 x 2-AD-12, 1 x 2-DU-65 1 x 2-DU-10, 1 x SW-19, 1 x SW-27
basic set Type2 1/2" system l = 240 mm
5 x 2-GE, 1 x 2-GE-3, 1 x 2-AD-38, 1 x 2-AD-12, 1 x 2-DU-65 1 x 2-DU-10, 1 x SW-19, 1 x SW-27

VUE D'ENSEMBLE DES PRODUITS

Typ3 [3/4"]



Le système Typ3, appelé aussi système 3/4", promet la stabilité qui convient à vos machines – en plus d'une qualité éprouvée et fiable. La section de passage de Ø 19 mm fournit le débit nécessaire (plus de 200 l/mn), de façon précise et stable (jusqu'à 60 bars), depuis la pompe jusqu'à l'outil. Il existe actuellement plus de 25 buses différentes, qui sont adaptées à ce système, depuis de simples buses rondes à partir de Ø 12 mm, Ø 15 mm et Ø 19 mm, jusqu'à la plus grande buse plate de 101 mm x 2 mm. Les buses conviennent aussi de façon optimale pour le meulage. Toutes les buses

sont fabriquées avec une haute précision et sont aisément interchangeables, quelle que soit l'application. Grâce aux adaptateurs 3/8", 3/4" et 1", le système se laisse facilement installer sur chaque machine. Comme d'habitude, il existe aussi différents éléments de base et éléments coudés, qui permettent de configurer le système de façon flexible et selon les souhaits. En option, il est possible d'acquérir un robinet à rotule ou d'autres accessoires.

DONNÉES TECHNIQUES:

- Taille Typ3 (3/4")
- Section de passage Ø 19,0 mm
- Résistance à la pression jusqu'à 60 bars
- Champ d'utilisation -30° C jusqu'à +60° C
- En option, système ES extra robuste jusqu'à +300° C (disponible sur demande)
- Filetage (éléments) M34 x 1,25
- Matériau 1.4305 (V2A)

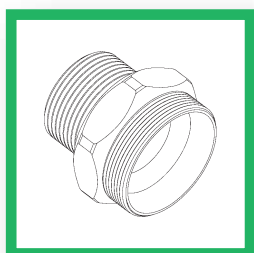
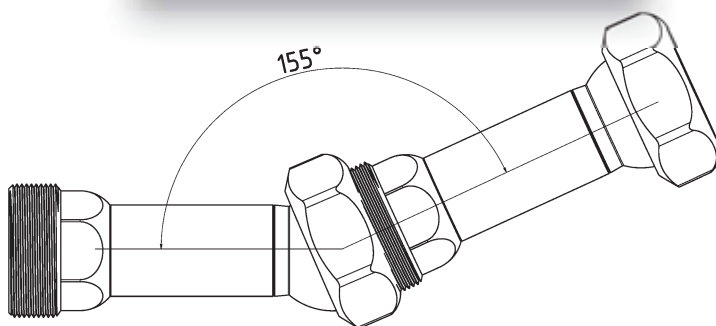
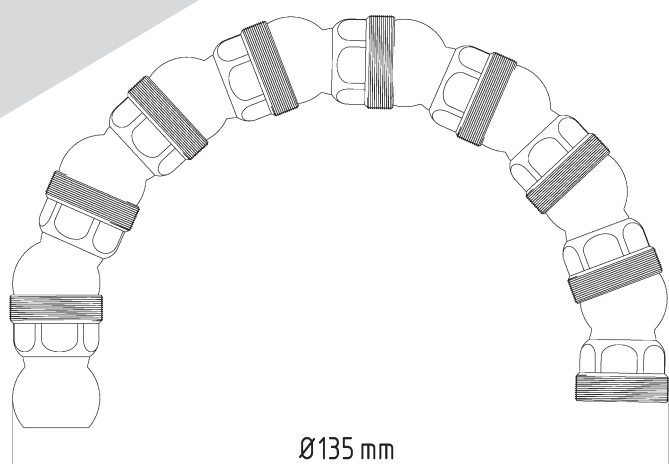

ADAPTATEURS MACHINE

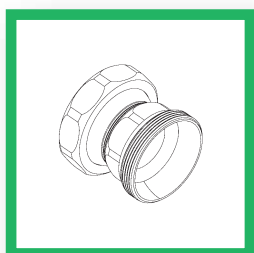

ÉLÉMENTS DE BASE

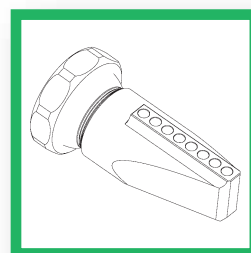

BUSES

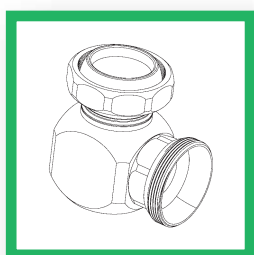

ÉLÉMENTS COUDÉS

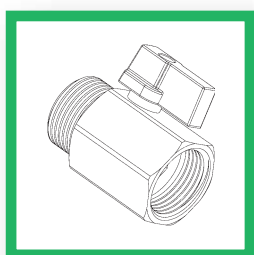

ACCESSOIRES

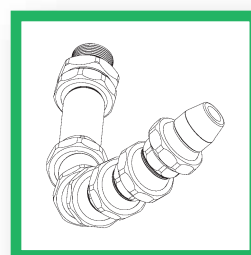

ACCESSOIRES Typ3

Typ3 [Système 3/4"]

Éléments de base | Basic Elements

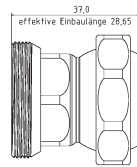
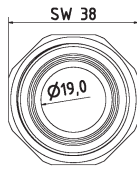

3-GE

L. = 37 mm | L. effective = 28,6 mm
l = 37 mm effective l = 28,6 mm

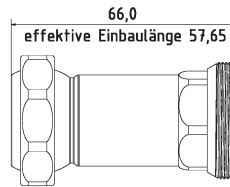
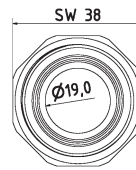

3-GE-2

L. = 66 mm | L. effective = 57,6 mm
l = 66 mm effective l = 57,6 mm

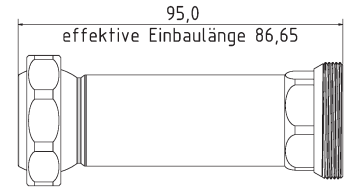
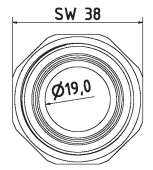

3-GE-3

L. = 95 mm | L. effective = 86,6 mm
l = 95 mm effective l = 86,6 mm

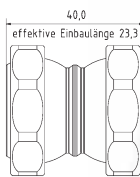
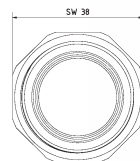

3-GE-DK Élément spécial

Élément de base L. x 40 mm L. effective 23,3 mm
basic element l x 40 mm effective l x 23,3 mm

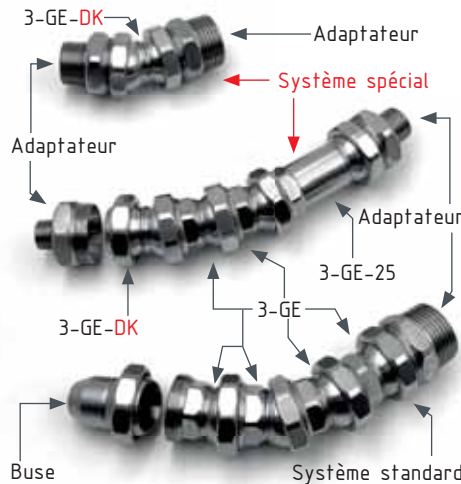

Adaptateurs machine/buse | Machine-/Nozzle Adapter

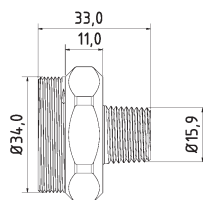
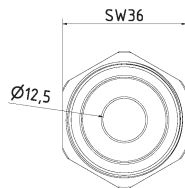

3-AD-38-PT

Raccord adaptateur filetage 3/8" PT (filetage NPT)
adaptor piece thread 3/8" PT (NPT thread)

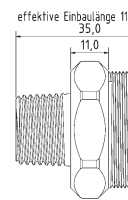

3-AD-12-PT

Raccord adaptateur filetage G 1/2" PT (filetage NPT)
adaptor piece thread 1/2" PT (NPT thread)

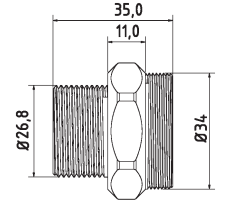
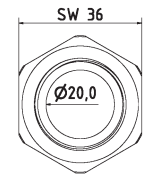

3-AD-34-PT

Raccord adaptateur filetage 3/4" PT (filetage NPT)
adaptor piece thread 3/4" PT (NPT thread)

Adaptateurs machine/buse | Machine-/Nozzle Adapter

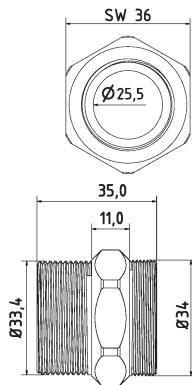

3-AD-10-PT

Raccord adaptateur filetage 1" PT (filetage NPT)
adaptor piece thread G 1" PT (NPT thread)

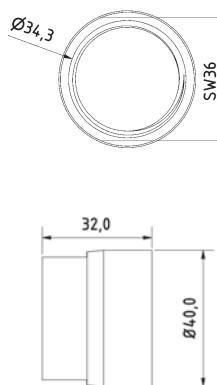

3-AD-3GE-1

Raccord adaptateur pour buses étrangères avec
filetage mâle, filetage femelle 3-GE sur femelle 1"
*adapter piece for external nozzles with male
thread, female 3-GE to female 1"*

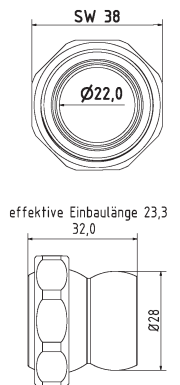

3-AD-LL

Raccord adaptateur Loc-Line Typ 3
adaptor piece Loc-Line Type 3

Éléments coudés | Elbows

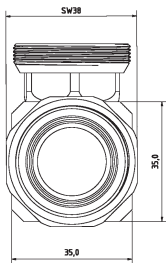

3-WV-1K

Raccord coudé à rotule
elbow piece movable

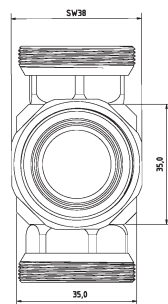

3-WV-2K

Raccord en T à rotule
T-piece movable

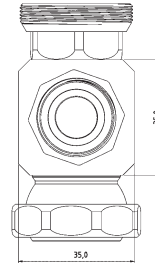

3-WV-R-2K

Raccord en T pour bague et buse
T-piece fo ring and nozzle

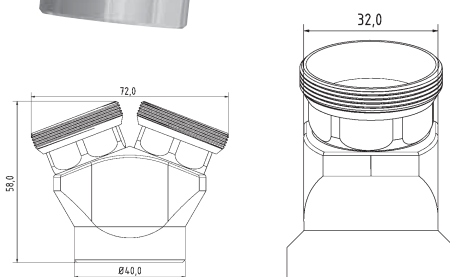
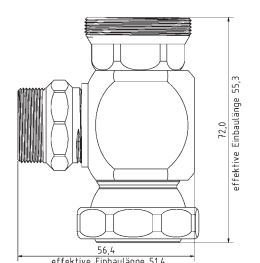

3-YV

Raccord en Y 50°
Y-piece 50°

Typ3 [Système 3/4"]

Buses | Nozzles

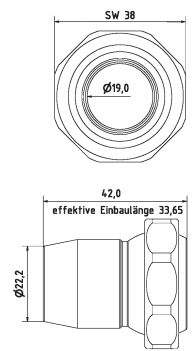
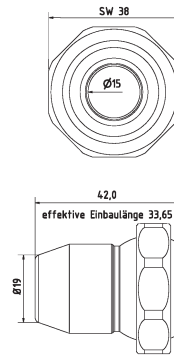
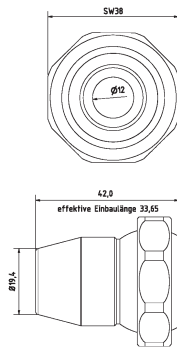

3-DU-12

Buse à jet rectiligne perçage Ø 12 mm
nozzle straight Ø 12 mm

3-DU-15

Buse à jet rectiligne perçage Ø 15 mm
nozzle straight Ø 15 mm

3-DU-19

Buse à jet rectiligne perçage Ø 19 mm
nozzle straight Ø 19 mm

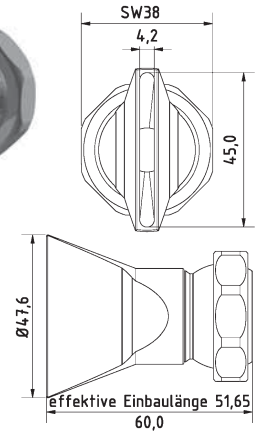
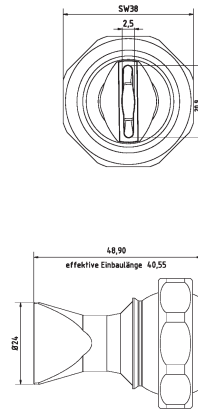
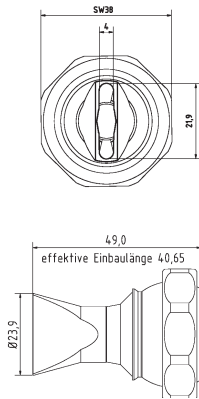

3-DU-SL-25

Buse plate largeur fente 22 x 4,0 mm
à jet de dispersion
flat nozzle broadly with slit 22 x 4,0 mm
scattered beam

3-DU-SL-25-SS

Buse plate largeur fente 20 x 2,5 mm
à jet de dispersion
flat nozzle broadly with slit 20 x 2,5 mm
scattered beam

3-DU-SL-50

Buse plate largeur fente 45 x 4,2 mm
à jet de dispersion
flat nozzle broadly with slit 45 x 4,2 mm
scattered beam

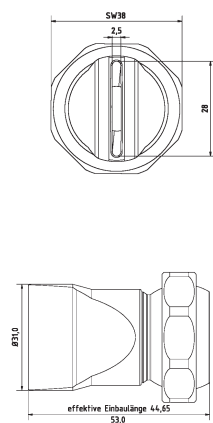
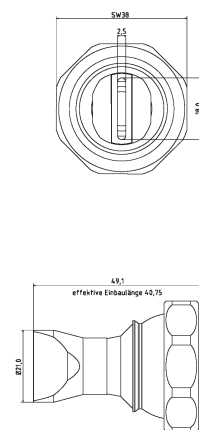

3-DU-SL-25-GS

Buse plate largeur fente 18 x 2,5 mm
à jet rectiligne
flat nozzle broadly with slit 18 x 2,5 mm
straight jet

3-DU-SL-31-GS

Buse plate largeur fente 28 x 2,5 mm
à jet rectiligne
flat nozzle broadly with slit 28 x 2,5 mm
straight jet

Buses | Nozzles

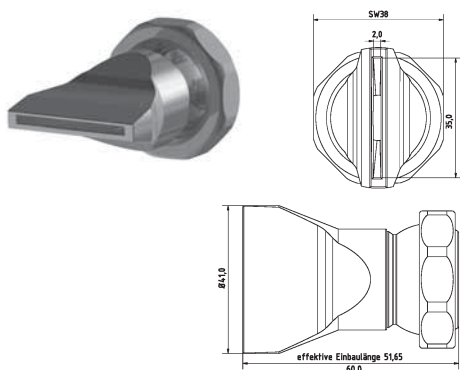

3-DU-SL-50-GS

Buse plate largeur fente 35 x 2,0 mm
à jet rectiligne
*flat nozzle broadly with slit 35 x 2,0 mm
straight jet*

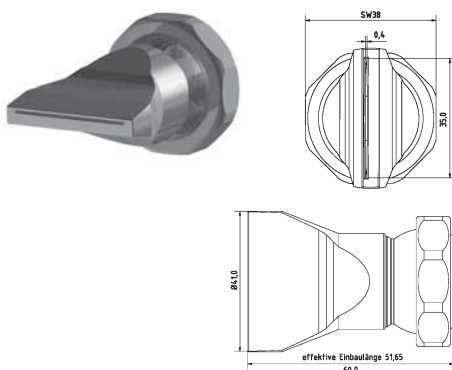

3-DU-SL-50-GS-0.4

Buse plate largeur fente 35 x 0,4 mm
à jet rectiligne
*flat nozzle broadly with slit 35 x 0,4 mm
straight jet*

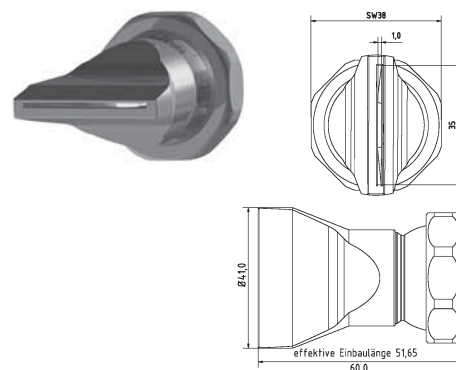

3-DU-SL-50-GS-1.0

Buse plate largeur fente 35 x 1,0 mm
à jet rectiligne
*flat nozzle broadly with slit 35 x 1,0 mm
straight jet*

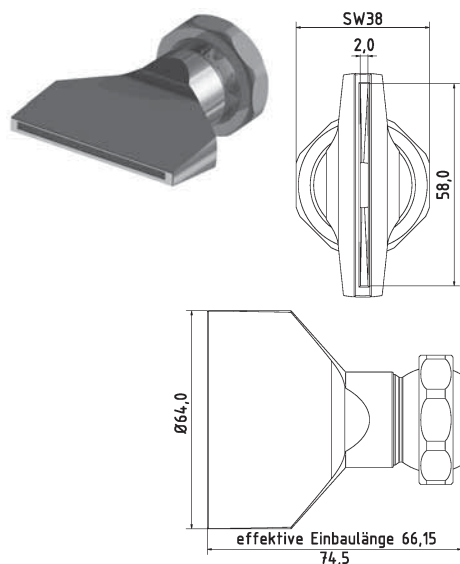

3-DU-SL-65-GS

Buse plate largeur fente 58 x 2,0 mm
à jet rectiligne
*flat nozzle broadly with slit 58 x 2,0 mm
straight jet*

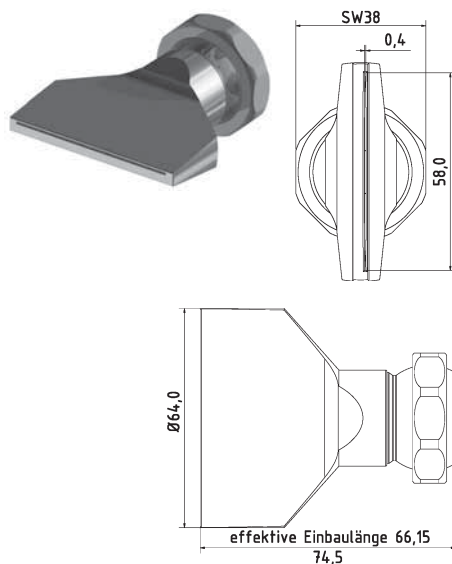

3-DU-SL-65-GS-0.4

Buse plate largeur fente 58 x 0,4 mm
à jet rectiligne
*flat nozzle broadly with slit 58 x 0,4 mm
straight jet*

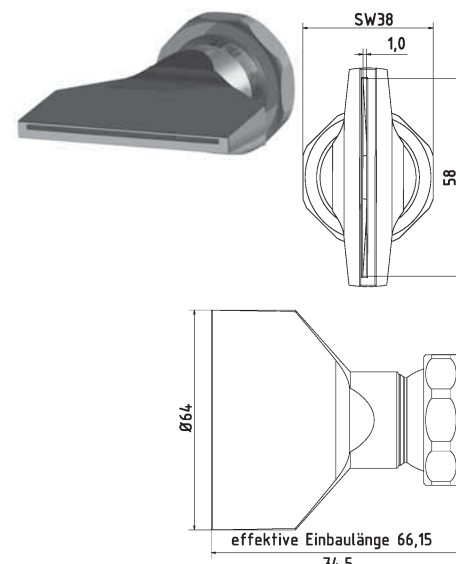

3-DU-SL-65-GS-1.0

Buse plate largeur fente 58 x 1,0 mm
à jet rectiligne
*flat nozzle broadly with slit 58 x 1,0 mm
straight jet*

Typ3 [Système 3/4"]

Buses | Nozzles

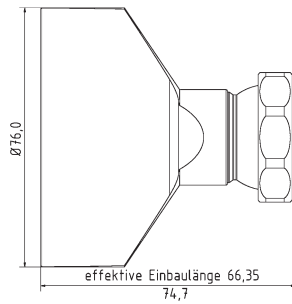
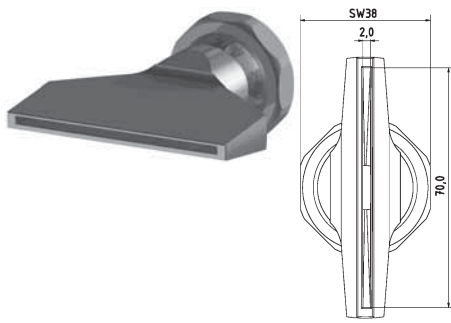

3-DU-SL-76-GS

Buse plate largeur fente 70 x 2,0 mm
à jet rectiligne
*flat nozzle broadly with slit 70 x 2,0 mm
straight jet*

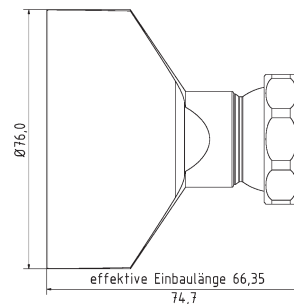
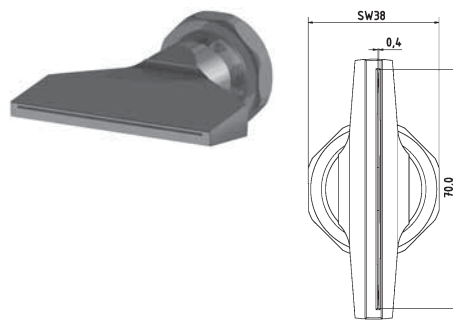

3-DU-SL-76-GS-0.4

Buse plate largeur fente 70 x 0,4 mm
à jet rectiligne
*flat nozzle broadly with slit 70 x 0,4 mm
straight jet*

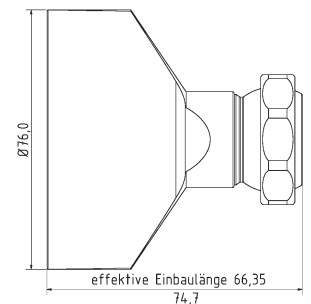
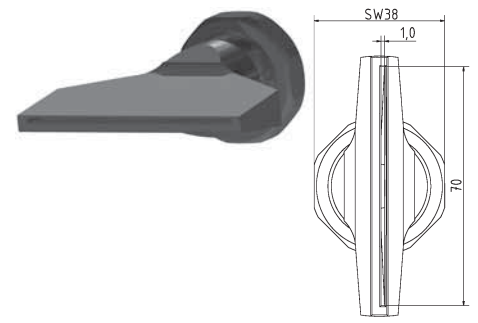

3-DU-SL-76-GS-1.0

Buse plate largeur fente 70 x 1,0 mm
à jet rectiligne
*flat nozzle broadly with slit 70 x 1,0 mm
straight jet*

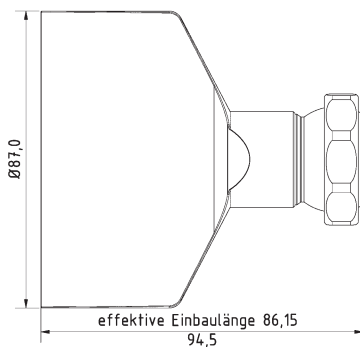
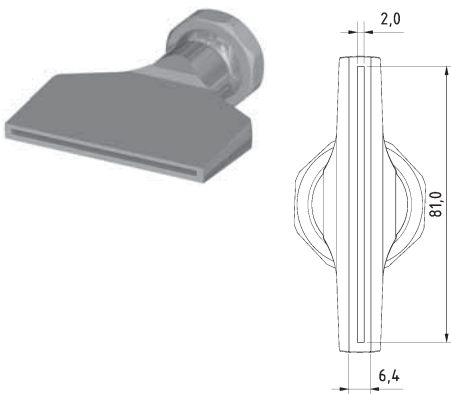

3-DU-SL-87-GS

Buse plate largeur fente 81 x 2,0 mm
à jet rectiligne
*flat nozzle broadly with slit 81 x 2,0 mm
straight jet*

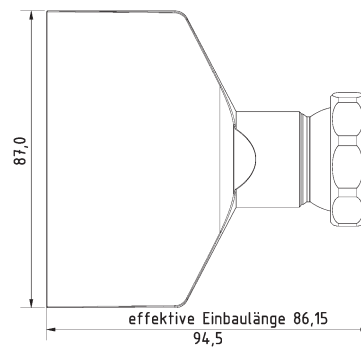
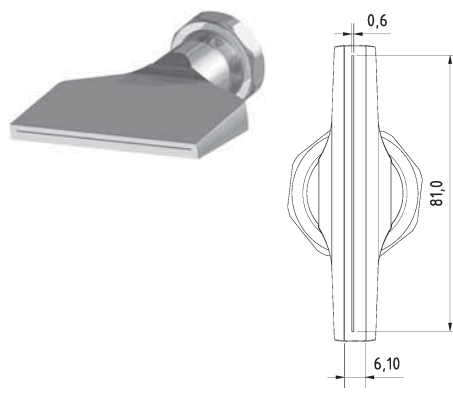

3-DU-SL-87-GS-0.6

Buse plate largeur fente 81 x 0,6 mm
à jet rectiligne
*flat nozzle broadly with slit 81 x 0,6 mm
straight jet*

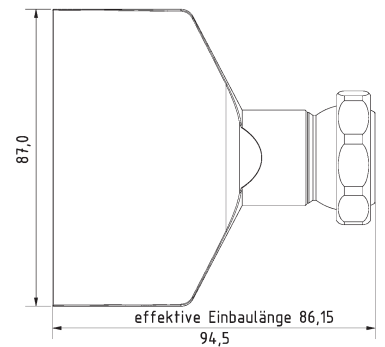
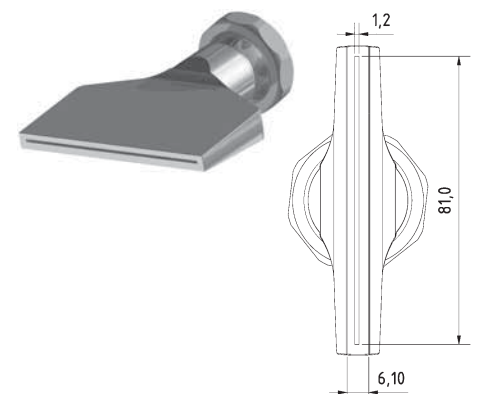

3-DU-SL-87-GS-1.2

Buse plate largeur fente 81 x 1,2 mm
à jet rectiligne
*flat nozzle broadly with slit 81 x 1,2 mm
straight je*

Buses | Nozzles

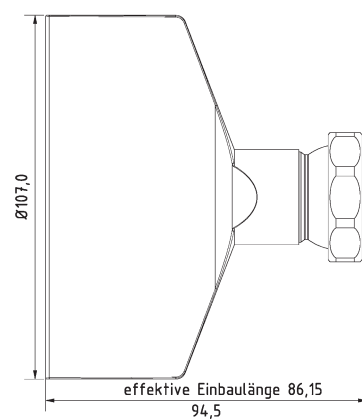
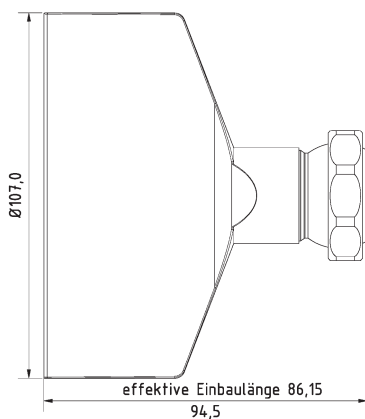
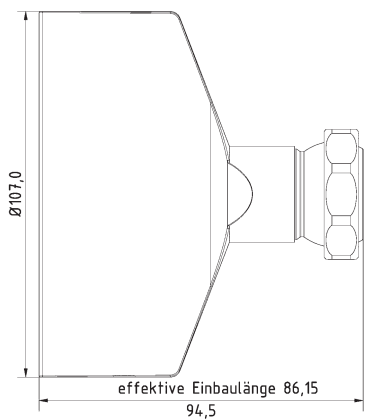
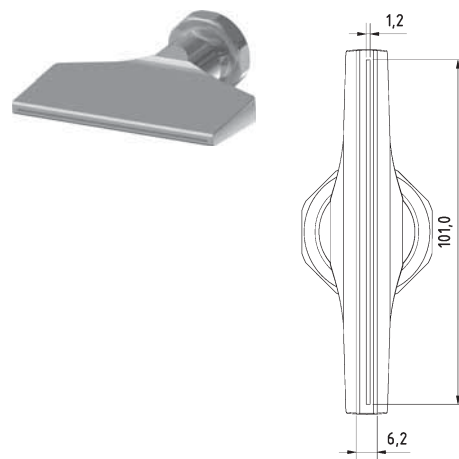
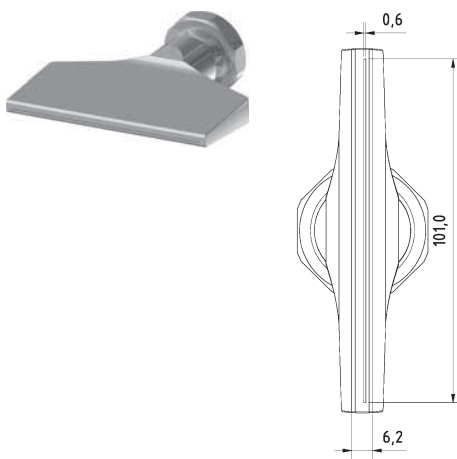
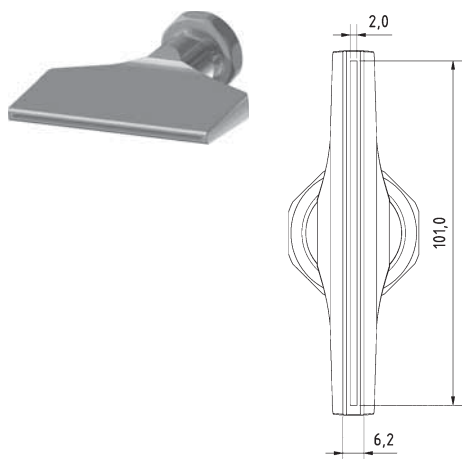

3-DU-SL-107-GS

Buse plate largeur fente 101 x 2,0 mm
à jet rectiligne
*flat nozzle broadly with slit 101 x 2,0 mm
straight jet*

3-DU-SL-107-GS-0.6

Buse plate largeur fente 101 x 0,6 mm
à jet rectiligne
*flat nozzle broadly with slit 101 x 0,6 mm
straight jet*

3-DU-SL-107-GS-1.2

Buse plate largeur fente 101 x 1,2 mm
à jet rectiligne
*flat nozzle broadly with slit 101 x 1,2 mm
straight jet*

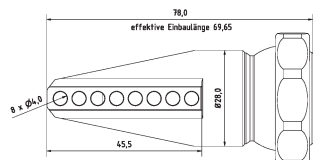
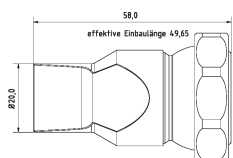
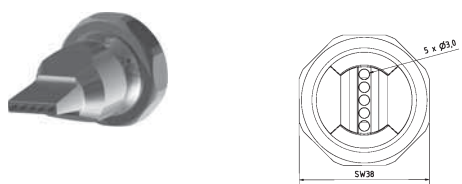

3-DU-LL-5-3

Buse à jet rectiligne avec perçage 5 x Ø 3 mm
nozzle straight with holes 5 x Ø 3 mm

3-DU-LL-90-8

Buse à jet 90° avec perçage 8 x Ø 4 mm
nozzle 90° with holes 8 x Ø 4 mm

Typ3 [Système 3/4"]

Accessoires | Accessories

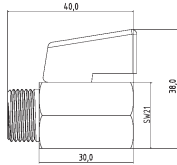
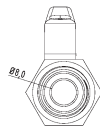

KH-38

Mini robinet à rotule filetage 3/8" laiton chromé
mini ball valve thread 3/8" brass chrome-plated

KH-38-SS

Mini robinet à rotule filetage 3/8" acier inoxydable
mini ball valve thread 3/8" stainless steel

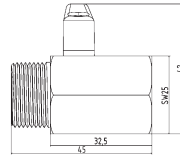
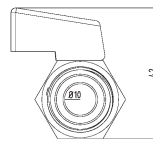

KH-12

Mini robinet à rotule filetage 1/2" laiton chromé
mini ball valve thread 1/2" brass chrome-plated

KH-12-SS

Mini robinet à rotule filetage 1/2" acier inoxydable
mini ball valve thread 1/2" stainless steel

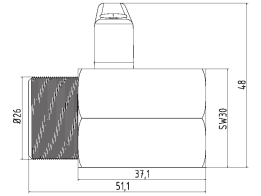
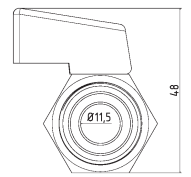

KH-34

Mini robinet à rotule filetage 3/4" laiton chromé
mini ball valve thread 3/4" brass chrome-plated



3-SW-27

Clé plate en acier SW 27
open end wrench SW 27



3-SW-38

Clé plate en acier SW 38
open end wrench SW 38

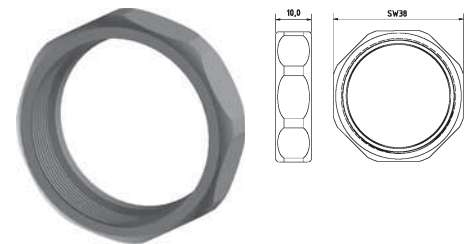

3-MU

Écrou standard
screw nut (default)

Kit de base | Basic Set

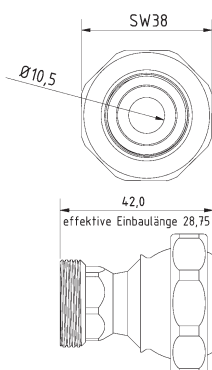

RE-3-2

Pièce de réduction Typ3 sur Typ2
reduction Type 3 to Type 2

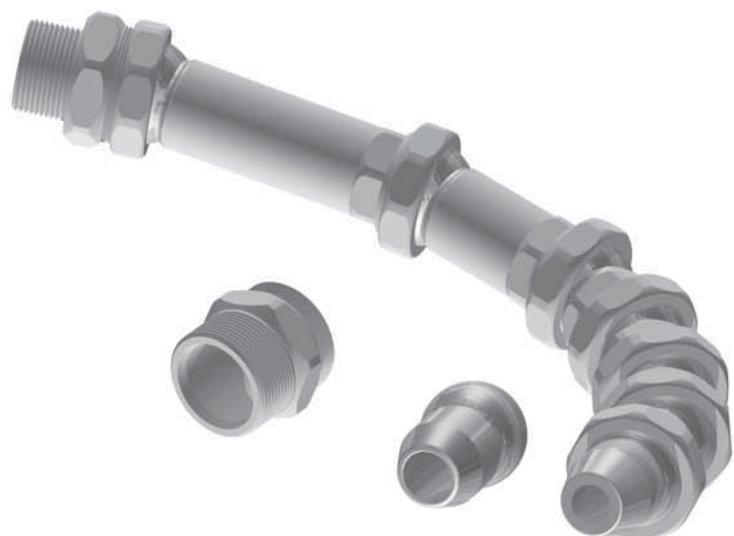

3-GS

Kit de base Typ3 Système 3/4" L. = 320 mm
basic set Type3 3/4" system l = 320 mm
4 x 3-GE, 1 x 3-GE-2, 1 x 3-GE-3, 1 x 3-AD-34PT, 1 x 3-AD-10PT, 1 x 3-DU-12,
1 x 3-DU-15, 1 x 3-SW-27, 1 x 3-SW-38

DES BUSES INNOVANTES POUR
DES PERFORMANCES MAXIMALES



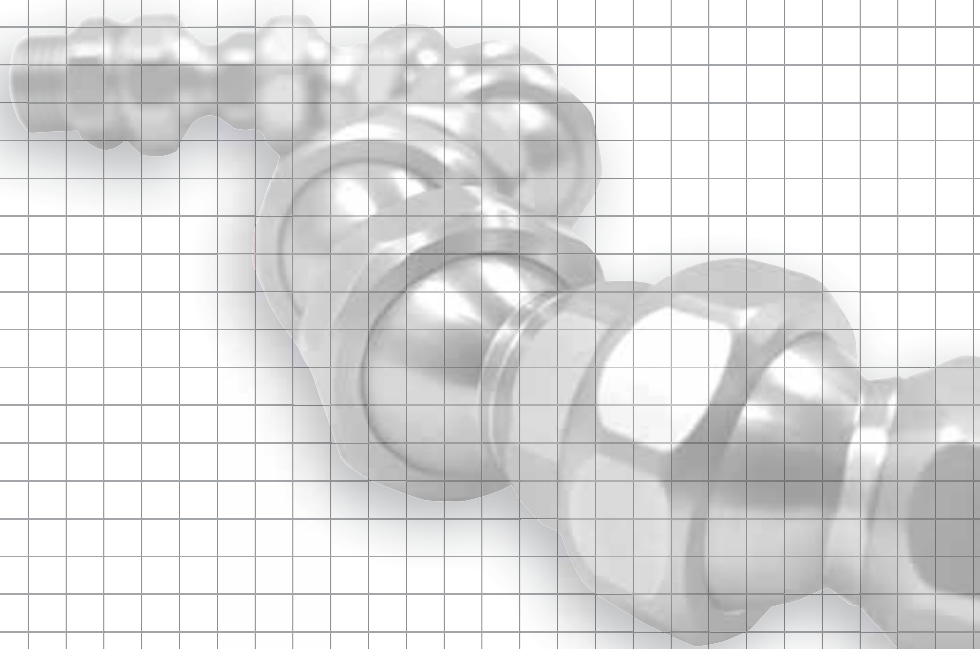

UN SUPPORT

PERFORMANT

ET PLUS RAPIDE

Nous vous conseillons volontiers personnellement sur les avantages de nos systèmes de conduites de lubrification et de refroidissement

Hirt[®]
LINE

www.kuehlmittelschlauch.com

Hirt-Line Europe

Seestr. 16
CH-8268 Salenstein

Tél.: +41 71 53 43 959
Fax: +41 71 53 43 953
info@hirt-line-europe.com

Les illustrations peuvent diverger de l'original. Sous réserve de modification des données techniques à tout moment et sans préavis. Toute reproduction, intégrale ou partielle, du produit ainsi que des technologies associées, est interdite. Hirt-Line® est un nom déposé. Sous réserve de modifications techniques et d'erreurs.
All illustrations are for reference only. The technical datas are subject to change. A copy of the product, whether in whole or in part, and the related technologies is prohibited.
Hirt-Line® is a registered name. Technical amendmends and errors may occur.